

KRASO[®]

SIMPLE + TIGHT



Catalogue 01 | 2024

WATER PRESSURE TIGHT INSTALLATION PARTS FOR CONCRETE ENGINEERING
SEALING SOLUTIONS FOR CABLES + PIPES



MADE IN GERMANY – IN USE WORLDWIDE!



- + We have been developing, producing and distributing our water pressure tight installation parts from our company site in Rhede in North Rhine-Westphalia **for over 40 years**.
- + As a **family company** with over 130 employees we feel obliged to the quality feature **“Made in Germany”!**
- + Together with our distributors we supply national and international sales partners!
- + We already supply to the following countries: **Australia, Austria, Belgium, Bosnia, Bulgaria, Canada, Croatia, Cyprus, Czech Republic, Denmark, Dubai, Estonia, Finland, France, Germany, Great Britain, Greece, Hungary, Iceland, Ireland, Italy, Luxemburg, Madagascar, Norway, Poland, Romania, Slovakia, Slovenia, Spain, Sweden, Switzerland, The Netherlands, Ukraine, USA, Vietnam**

DEAR CUSTOMER, DEAR DEALER!

Our current **KRASO®** Catalogue 01|2024 once again presents the entire range of sealing solutions and water pressure tight installation parts from sealing inserts, pipe and cable penetrations to joint tapes and precast concrete parts. We have more than 40 years of experience in sealing technology. With passion, innovative strength and in close cooperation with practical experience, we have developed a product range that is second to none in terms of diversity and versatility!

Since our company was founded, we have focussed on **joint sealings**. We have significantly expanded our manufacturing competence in this sector and combined all solutions under the **KRASOflex®** brand. This includes e.g. the new **KRASOflex® 155 Construction Joint Tape**, which is both **stable and flexible** like a joint plate made of plastic. As an alternative, we now also offer the **KRASOflex® Joint Plate ZVB** as a **cement composite plate with a special mineral coating**. As far as joint and corner areas in the wall are concerned, you can now use our desired crack elements on joint tape and joint plate basis. We have also expanded our range of **internal and external construction and expansion joint tapes according to factory standard, DIN 18541 and DIN 15841 BV**. **Formwork elements, expansion joint tapes and expansion rubbers** complete our product category **Joint Tapes** to a full range for almost all types of joints in water-proof concrete construction! You can find all products from page 133.

Even with a low nominal water level, penetrations should offer sufficient protection in order to avoid unpleasant surprises when the groundwater level rises. This is where the new **KRASO® Wall Collars** come into play. They **provide protection against pressing water up to 5 bar – MPA-tested!** The installation is carried out **without tools or with the new Torque Control Wrench KRASO® DKS** included in the scope of supply. We have developed a special solution for protection against lightning: the **KRASO® Wall Collar Lightning Protection Duo** can be used **both for earthing strap and ground wire**. Find out more about the **KRASO® Wall Collar** from page 79.

In addition to our plastic casing with **KRASO® 4 Seal**, we also offer **fibre cement casings**. We have expanded our production in this segment and are pleased to be able to supply you with **almost all wall thicknesses and diameters**. The corresponding overview is listed on page 93.

Ribbed media lines can be externally sealed with the **KRASO® Sealing Insert Type GR**. For an **internal sealing of cable protective hoses**, we now offer the **KRASO® Sealing Insert Type IN-GR**. This can be used for the water pressure and gas-tight sealing of one or several cables. You will find the **KRASO® Sealing Insert Type IN-GR** on page 17.

With these and further product innovations and additions, we provide you with solutions for the quick, easy and effective sealing of all construction projects using **the very latest technology** - for every requirement at an **unbeatable price-performance ratio!** And keep in mind: we always find an **individual and customised solution for special cases with our special designs made of steel, plastic and concrete!**



Jürgen Krasemann sen.
Managing Partner



Jürgen Krasemann
Managing Partner



Dennis Krasemann
Managing Partner



Christoph Bölting
General Manager





Dimensions and weights without warranty • Colour deviations from the illustrated and delivered product possible • Subject to technical changes • All rights on drawings and designs are the property of **KRASO GmbH & Co. KG**. • Reproduction and distribution of the drawings and any other use require our written consent • All prices are net plus applicable VAT

TABLE OF CONTENTS

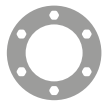

Sealing Inserts

Universal DD (p. 11) + Type ED + DD + VD (p. 13) + Type SD (p. 14) + Universal Multiple - split - (p. 15) + Type GR (p. 16) + Type IN-GR® (p. 17) + Type TD-X (p. 18) + Type FIX (p. 19) + Type Blind ED + DD + VD (p. 19) + Foil Clamping Flange Type FKF (p. 20) + Plastic Flange Plate Type KFP (from p. 23) + Multi-Flange Plate Type MFP (p. 26) + Fixed-Loose Flange (from p. 27)



Utility Connection - Entries

Builder's Convenience Box - floor (p. 34) + Builder's Convenience Box - floor - 110 (p. 38) + Builder's Convenience Box - floor - 150 (p. 41) + Builder's Convenience Box - floor - NFE (p. 42) + Builder's Convenience Box - wall (p. 45) + Builder's Convenience Box - wall - NFE (p. 47) + Builder's Convenience Box - wall - ESH (p. 49) + Builder's Convenience Box - wall - SWP (p. 51) + BKP Sealing Inserts (p. 53) + BKP Gas Installation Set (p. 54)



Utility Connection - Outlets

Builder's Convenience Box - floor - garden (p. 56) + Builder's Convenience Box - wall - garden (p. 59)



Cable Penetrations

Cable Penetration KDS (Double) Wall Penetration (p. 62) + Cable Inlet Box System KDS 150 (p. 67) + Flexible Empty Pipe System (p. 68) + KDS Accessories (p. 69) + Swan Neck (p. 72) + Universal Multiple - split - (p. 74)



Pipe Penetrations

Floor Penetration Type BDF (p. 76) + Universal Funnel (p. 78) + Wall Collar (p. 79) + Wall Penetration Type B (p. 82) + Wall Penetration Type FR (p. 84) + Wall Penetration Type Universal (p. 84) + Wall Penetration Type B/SF 5 (p. 86) + Wall Penetration Type DFW (p. 87) + Casings (from p. 88) + Fibre Cement Casing (from p. 91) + Tie Points (p. 94) + Drains (p. 95) + Flange Pipes (p. 104)



Solutions for Fresh Concrete Composite Films (FBV)

Floor Penetration Type FBV-BDF (p. 108) + Wall Penetration Type FBV-FR (p. 109) + Casing Type FBV-FE (p. 110) + Sealing Insert Type FBV/GF (p. 111) + Cable Penetration FBV-KDS (p. 112) + Fresh Concrete Composite Films (FBV) (p. 113)



Pump Sumps

Pump Sump - concrete - (p. 116) + Pump Sump Type Q (p. 117) + Covers (p. 118) + Inspection Shaft - concrete - (p. 121) + Backwater Shaft Type Q - faeces - (p. 121) + Pump Sump Type Q - faeces - (p. 124) + Pump Sump Poly 400 - KG 2000 (p. 125) + Accessories (p. 128)



KRASOflex® Joint Tapes

KRASOflex® 155 (p. 135) + Duo-Fix 150 „plus“ (p. 136) + Star Tubes (p. 138) + AFW 150 (p. 139) + KM Sheet (p. 139) + Joint Plate ZVB (p. 140) + Joint Plate ZVB - Desired Crack Elements (p. 141) + Formwork Elements (p. 142) + Bentonit Expansion Joint Tape (p. 143) + Expansion Rubber (p. 143) + Construction and Expansion Joint Tapes (p. 146) + Moulded Parts (p. 148) + Clamp Constructions (p. 150)



Special Designs

Stainless steel (p. 152) + Plastic (p. 154) + Concrete (p. 156)

YOUR KRASO® CONTACT FOR DAILY BUSINESS (p. 160)

STANDARDS, REGULATIONS AND RULES

DIN 18532
Waterproofing
of areas
made of
concrete
with traffic

DIN 18534
Waterproofing
of
interior
spaces

DIN 18531
Waterproofing of
roofs, balconies
and walkways

DIN 18533
Waterproofing
of elements
in contact
with soil

DIN 18535
Waterproofing of
water tanks and pools

DIN 18533 - waterproofing of elements in contact with soil

In order to get an effective waterproofing of elements in contact with soil, the type of water impact is defined for DIN 18533. The impact differs depending on type and intensity. Which of the four water classes is given results from the measured water level or the measured groundwater level to be determined in relation to the object (HGW) or the measured high water level (HHW).

The following water impact classes are defined:

- **W1-E** Soil moisture and non-pressing water
- **W1.1 -E** Soil moisture with base plates
- **W1.2 -E** Soil moisture and non-pressing water with walls and base plates in contact with soil
- **W2-E** Pressing water
- **W2.1 -E** Moderate impact of pressing water (water column ≤ 3 metres)
- **W2.2 -E** High impact of pressing water (water column ≥ 3 metres)
- **W3-E** Non-pressing water on an underground covered by earth
- **W4-E** Splashed water on the wall base and capillary water in and below walls in contact with soil

The German Committee for Reinforced Concrete's (DAfStb e.V.) waterproof concrete guideline sets out detailed requirements for the planning and design for partially or fully embedded waterproof concrete structures and components. Among other things, two stress classes are defined:

- **Stress class 1 (BKL-1):** Standing and occasionally pressing water (ground water, high water, stratum water, occasionally standing seepage water)
- **Stress class 2 (BKL-2):** Ground moisture and water running down the wall (non-standing seepage water)

DAfStb's guideline
„Waterproof concrete
structures“
(waterproof concrete
guideline)

**DIN 18322,
VOB Part C
General Technical
Specifications in
Construction Contracts
(ATV) – underground
line laying**

Among other things, this standard defines the general technical contractual conditions that apply to underground line laying regarding construction materials, the design, the primary and ancillary services, billing as well as for laying cables, protective pipes, micro pipes and micro pipes bundles, along with the manufacturing and maintenance of cable ducts.

**DIN 18336,
VOB Part C – A
General Technical Specifications in Construction
Contracts (ATV)
– sealing work**

This defines, among others, the waterproofing of components in contact with soil including manufacturing of the necessary insulation, vapour barrier and protective layers. It also applies to retroactive waterproofing of components in contact with soil.

**AGFW FW 419
work sheet,
DVGW GW 390
work sheet,
VDE-AR-N 4223
application guide**

These work sheets or application guides for building penetrations and sealing these for underground lines were put together by a working group of specialist associations, including: AGFW e.V. (district heating), DVGW e.V. (gas/water), VDE e.V. (electricity/telecommunication).

Subsequent sealing of components in contact with the soil is defined in this work sheet from the Wissenschaftlich-Technische Arbeitsgemeinschaft für Bauwerkserhaltung und Denkmalpflege (Scientific and Technical Working Group for Building Conservation and Monument Preservation).

This European standard sets out the requirements for solid wall pipes, moulded parts and pipeline systems made out of plasticiser-free polyvinylchloride (PVC-U) for sewers and pipelines that are used in underground gravity drainage systems both within and outside the structure of the building. It applies to pipes made of unfoamed PVC-U with smooth ends as well as with a preformed sleeve.

**DIN EN 1401
(KG pipe)**

**WTA leaflet
4-6-14/D**

This European standard specifies the requirements for solid wall pipes, moulded parts and pipeline systems made out of mineral-filled polypropylene (PP-MD) for sewers and pipelines that are used in underground gravity drainage systems outside the structure of the building. It applies to pipes made of PP-MD, both with and without preformed plug-in sleeve.

**DIN EN 14758
(KG 2000 pipe)**

DIN EN 61386-24

This European standard contains, among other things, the requirements and tests for underground electrical installation systems consisting of installation pipes and accessory parts and applies to metallic, non-metallic as well as mixed systems.

TESTED PRODUCTS – PROVEN ON SITE

- + With more than 40 years of experience in sealing technology, thousands of convinced customers and successfully sealed buildings we know what really matters: simple and tight! Following our own philosophy, our products must be simple in use with a reliable sealing.
- + We offer a complete and co-ordinated product range for the secure sealing of buildings - always paying close attention to the highest quality standards in construction, material and production!
- + The quality of our products is regularly verified by independent institutes! Tested in the laboratory and proven on the construction-site - always be on the safe side with **KRASO®** products.



KRASO® Products with the „FHRK Quality“ seal satisfy the test principles of the Fachverband Haus-einführungen für Rohre und Kabel e.V. (FHRK e.V.). The tests cover all loads to which sealing inserts, utility connection systems, pipe penetrations and casings are exposed: these include, among other things, standards regarding impermeability to gas and water, abrasion resistance when filling the casing or durability when compressing the trench.



KRASO® Products with the „FHRK Radon Tight“ seal have been tested in accordance with FHRK and/ or DVGW testing principles regarding gas and water tightness and also have successfully completed an IAF test for diffusion resistance. Products with this seal are considered to be radon-tight!



The **KRASO®** Builder's Convenience Box has the approval from DVGW (German Technical and Scientific Association for Gas and Water) according to DVGW VP 601 as utility connection for gas and water and therefore fulfils all directives for a gas- and water pressure tight installation.



As far as our wall and pipe penetrations are concerned, our **KRASO® 4 Seal** reliably protects against pressing water: the material testing institute certifies a water pressure tightness up to 10 bar! Due to its construction, the **KRASO® 4 Seal** is mechanically fixed with the concrete. The monolithic (force-fit) connection to the solid wall pipe completely prevents any creep or slippage.



Whether **KRASO®** Pump Sumps made of concrete, Flange Plates, Tie Points or Sealing Inserts: they all offer reliable protection against pressing water due to their construction, material and processing. **All these products** have been tested by independent material testing institutes regarding their water pressure tightness and **are water pressure tight up to 10 bar!**



Not only against pressing water – **KRASO®** Sealing Inserts are gas- and odour-tight and therefore rated high-quality in terms of TA-Air! Due to a successful examination in a material testing institute, our sealing inserts fulfil the administrative regulation to the Federal Immission Control Act: „Technical Instructions on Air Quality Control“.



Radon (Rn) is a radioactive noble gas that occurs in rock earth and can enter basement rooms through leakages. Radon is the second most reason for lung cancer. Pipe penetrations with **KRASO® 4 Seal** and **KRASO® Sealing Inserts** are gas-tight and protect securely against radon: IAF-tested!



The DVGW research centre at the Engler-Bunte Institute (EBI) of the Karlsruhe Institute of Technology has tested **KRASO®** Sealing Inserts according to DIN EN 13611 (chapter 7.2) and confirmed their gas-tightness. This means that our sealing inserts fulfil an important criteria of the German Technical and Scientific Association for Gas and Water.



The fire resistance class indicates the categorisation of building materials and components according to their fire resistance as regulated by the DIN standard. It consists of the code letter „F“ and the duration of functional integrity in the event of fire in minutes. The fire resistance class **F 180** stands for a „highly fire resistant“ component with 180 minutes of functional integrity.



KRASO® Joint Tapes, such as the **KRASOflex® Duo-Fix 150** „plus“, have received the certificate of usability according to the German Institute for Building Technology following testing by test centres recognised by the building authorities. The general building authority test certificate confirms the usability according to the state building regulations.



Products with Torque Control Nut **KRASO® DKM** can be installed without a torque wrench. The **KRASO® DKM** specifies the appropriate torque, which makes installation extremely easy and helps to avoid installation errors.



The material quality seal of **Warenzeichenverband Edelstahl Rostfrei e.V.** confirms the correct use of materials and correct processing of non-corrosive stainless steel in our products.



“White Tank“ Solutions

Sealing Insert Universal DD (p. 11) + Sealing Insert Universal DD/M (p. 12) + Sealing Insert Type ED + DD + VD (p. 13) + Sealing Insert Type SD (p. 14) + Sealing Insert Universal Multiple - split - (p. 15) + Sealing Insert Type GR (p. 16) + Sealing Insert Type IN-GR® (p. 17) + Sealing Insert Type TD-X (p. 18) + Sealing Insert Type FIX (p. 19) + Sealing Insert Type Blind ED + DD + VD (p. 19) + Plastic Flange Plate Type KFP (p. 23) + Multi-Flange Plate Type MFP (p. 26) + Flange Plate (p. 31)

“Black Tank“ Solutions

Foil Clamping Flange Type FKF (p. 20) + Foil Clamping Flange Type FKF DD/GR (p. 22) + Foil Clamping Flange Type FKF Universal (p. 22) + Plastic Flange Plate Type KFP - Foil Flange (from p. 23) + Casing Type FL/ZA (p. 28) + Casing Type FL/ZE (p. 29) + Sealing Insert Type FL (p. 30)

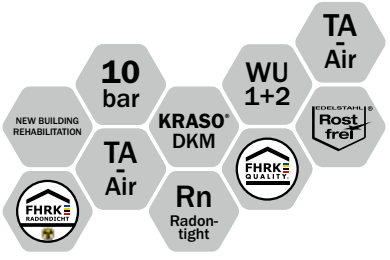

KRASO® Sealing Inserts

Simply just better

- + For core drillings or casings
- + **KRASO® Sealing Insert quality: 5 mm thick clamping plates** made of non-corrosive stainless steel V2A, a specially developed rubber mixture with even better sealing characteristics, welded-on studs instead of through bolts, more studs for even pressure distribution
- + Torque Control Nut **KRASO® DKM: integrated torque limiter - no torque wrench required!**
- + **Tested gas-tight according to DIN EN 13611 (chapter 7.12)** proven by the DVGW research centre at the Engler-Bunte-Institute (EBI) of the Institute for Technology in Karlsruhe
- + MPA-tested: protects reliably against pressurised water up to 10 bar!
- + **Gas- and odour-tight** – high-quality in terms of TA-Air!
- + **Radon tightness IAF tested** - meets the requirements for radon precautionary areas according to FHRK leaflet MB 101!
- + **Tested according to FHRK test specification GE 101!**
- + **KRASO® Sealing Insert Configurator** – simple and fast: configure the matching sealing insert online or via our app!



KRASO® Sealing Insert
Universal DD



KRASO® Sealing Insert
Type ED + DD + VD



KRASO® Sealing Insert
Type Blind ED + DD + VD



KRASO® Sealing Insert
Type GR



KRASO® Sealing Insert
Universal Multiple
- split -



KRASO® Sealing Insert
Type SD



KRASO® Sealing Insert
Type TD-X



Patented technology!

KRASO® DKM Torque Control Nut

- + Total control over torque and contact pressure!
- + Audible and tactile signal indicates the ideal torque!
- + Installation has never been so easy: no torque wrench required!
- + Can be loosened and retightened with automatic torque limitation!
- + Over-twisting and fretting: impossible!



KRASO® Sealing Insert Universal DD
Check the installation video
(just scan the QR code!)

**One
for all:
water-,
radon- and
gas-tight!**



KRASO® Sealing Insert Universal DD Simple, tight, universal use

- + For core drillings or casings
- + **Onion ring technology:** universal use for various external diameters of media pipes or cables!
- + **KRASO® Sealing Insert quality:** non-corrosive stainless steel V2A, high quality 40 mm rubber seal, welded-on studs instead of through bolts
- + Torque Control Nut **KRASO® DKM:** integrated torque limiter - no torque wrench required!
- + **MPA-tested:** protects reliably against pressing water up to 3 bar!
- + **Gas- and odour-tight** – high-quality in terms of TA-Air!
- + **Radon tightness IAF tested** - meets the requirements for radon precautionary areas according to FHRK leaflet MB 101!
- + **Tested according to FHRK test specification GE 101!**
- + **DafStB waterproof concrete guideline:** stress class 1 + 2



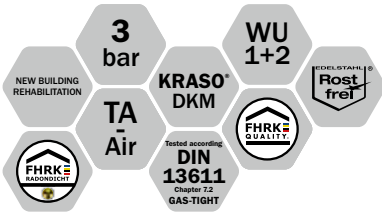

KRASO® Sealing Insert Universal DD **LG 1**

for installation of pipes or cables, double sealing against pressing water up to 3 bar. Can also be used as blind plug for feed-through of pipes or cables (except KRASO® Universal 250 DD and Universal 250 DD/T) | **DafStB waterproof concrete guideline: stress class 1 + 2**



Type / Item	KRASO® Universal DD					
Core drilling / casing in mm	Universal 80 DD	Universal 100 DD	Universal 100 DD/T <small>(split design for retrofit installation)</small>	Universal 110 DD	Universal 110 DD/T <small>(split design for retrofit installation)</small>	Universal 150 DD
A sealing insert for all pipes or cables listed in the table on the right (in mm)	stepless onion ring technology: 18 - 43 mm or blind	stepless onion ring technology: 18 - 65 mm or blind	stepless onion ring technology: 18 - 65 mm or blind	stepless onion ring technology: 18 - 75 mm or blind	stepless onion ring technology: 18 - 75 mm or blind	110 DN 110 KG pipe, DN 110 SML pipe
						90 DN 80 steel pipe, PE pipe
						75 DN 70 HT pipe
						blind
KRASO® Universal DD	52 €	56 €	62 €	61 €	67 €	84 €



Type / Item	KRASO® Universal DD					
Core drilling / casing in mm	Universal 150 DD/T <small>(split design for retrofit installation)</small>	Universal 160 DD/T <small>(split design for retrofit installation)</small>	Universal 200 DD	Universal 200 DD/T <small>(split design for retrofit installation)</small>	Universal 250 DD	Universal 250 DD/T <small>(split design for retrofit installation)</small>
A sealing insert for all pipes or cables listed in the table on the right (in mm)	stepless onion ring technology: 75 - 110 mm or blind	stepless onion ring technology: 75 - 110 mm or blind	160 DN 160 KG pipe, DN 160 SML pipe	stepless onion ring technology: 110 - 160 mm or blind	210 DN 200 SML pipe	210 DN 200 SML pipe
			135 DN 125 SML pipe		200 DN 200 KG pipe, DN 200 KG 2000	200 DN 200 KG pipe, DN 200 KG 2000
			125 DN 125 KG pipe		180 DN 170 PE pipe	180 DN 170 PE pipe
			110 DN 110 KG pipe, DN 110 SML pipe		170 steel/cast pipe	170 steel/cast pipe
			blind		160 DN 160 KG pipe, DN 160 SML pipe	160 DN 160 KG pipe, DN 160 SML pipe
KRASO® Universal DD	96 €	106 €	113 €	124 €	144 €	158 €



KRASO® Sealing Insert Universal DD/M **LG 1**

for simultaneous installation of up to 5 cables or pipes, double sealing against pressing water up to 3 bar, Torque Control Nut KRASO® DKM, non-corrosive stainless steel V2A, 40 mm seal. Can also be used as blind plug for feed-through of pipes or cables | **DafStB waterproof concrete guideline: stress class 1 + 2**

Type / Item	KRASO® Universal DD/M
Core drilling / casing in mm	100
A sealing insert for all pipes or cables listed in the table on the right (in mm)	1 x 8 - 10 mm or blind
	1 x 11 - 13 mm or blind
	1 x 14 - 16 mm or blind
	1 x 17 - 19 mm or blind
	and 1 x stepless onion ring technology: 20 - 35 mm or blind
KRASO® Universal DD/M	72 €



KRASO® Sealing Insert Type ED + DD + VD
Check the installation video
(just scan the QR code!)



KRASO® Type ED



KRASO® Type ED/T
(split design for retrofit installation)



KRASO® Type DD



KRASO® Type DD/T
(split design for retrofit installation)



KRASO® Type VD

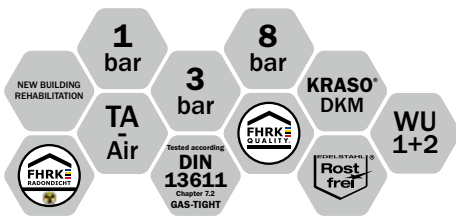

KRASO® Sealing Insert Type ED + DD + VD **LG 1**

for installation of pipes, Torque Control Nut **KRASO®** DKM, non-corrosive stainless steel V2A, single sealing, against pressing water up to 1 bar, 20 mm seal (**KRASO®** Type ED, **KRASO®** Type ED/T), double sealing, against pressing water up to 3 bar, 40 mm seal (**KRASO®** Type DD, **KRASO®** Type DD/T), quadruple sealing, against pressing water up to 8 bar, 80 mm seal (**KRASO®** Type VD) | DafStB waterproof concrete guideline: stress class 1 + 2

Type / Item	KRASO® Type ED • KRASO® Type DD • KRASO® Type VD • KRASO® Type ED - split - • KRASO® Type DD - split -									
Core drilling / casing in mm (from - to)	80 (79 - 83)	100 (99 - 103)	125 (124 - 128)	150 (149 - 153)	200 (198 - 203)	250 (248 - 253)	300 (298 - 303)	350 (348 - 353)	400 (398 - 403)	500 (497 - 503)
Media line (from - to)	25 (20 - 26)	32 (29 - 35)	63 (58 - 64)	75 (70 - 76)	110 (105 - 111)	160 (156 - 162)	200 (196 - 202)	200 (196 - 202)	273 (269 - 275)	400 (397 - 402)
	32 (29 - 35)	43 (38 - 44)	75 (72 - 78)	80 (75 - 81)	114 (113 - 119)	170 (165 - 171)	210 (206 - 212)	210 (206 - 212)	280 (276 - 282)	429 (426 - 431)
	43 (38 - 44)	50 (45 - 51)	80 (75 - 81)	90 (85 - 91)	125 (120 - 126)	180 (176 - 182)	219 (215 - 221)	219 (215 - 221)	315 (311 - 317)	450 (447 - 452)
		63 (58 - 64)		110 (105 - 111)	135 (130 - 136)	200 (196 - 202)	225 (221 - 227)	225 (221 - 227)	326 (322 - 328)	
					140 (135 - 141)	210 (206 - 212)	250 (246 - 252)	250 (246 - 252)		
					160 (155 - 161)			273 (269 - 275)		
								280 (276 - 282)		
KRASO® Type ED (20 mm)	51 €	56 €	69 €	77 €	106 €	125 €	164 €	178 €	192 €	276 €
KRASO® Type ED/T (20 mm - split design for retrofit installation)	59 €	64 €	79 €	89 €	122 €	144 €	189 €	205 €	221 €	317 €
KRASO® Type DD (40 mm)	61 €	70 €	86 €	102 €	128 €	149 €	216 €	257 €	298 €	374 €
KRASO® Type DD/T (40 mm - split design for retrofit installation)	70 €	81 €	99 €	117 €	147 €	171 €	248 €	296 €	343 €	430 €
KRASO® Type VD (80 mm)	76 €	88 €	108 €	128 €	160 €	186 €	270 €	321 €	373 €	468 €

Other diameters available as special sealing insert! All sealing inserts available in V4A at an additional charge!



KRASO® Sealing Insert Type SD
Check the installation video
(just scan the QR code!)



KRASO® Type SD 30



KRASO® Type SD 30 - T



KRASO® Type SD 30 - GF



KRASO® Type SD 60



KRASO® Type SD 60 - T



KRASO® Type SD 60 - GF



KRASO® Sealing Insert Type SD

The solution for special situations

Usually ready for dispatch within 24 hours!

- + For core drillings and casings
- + Individual and custom-made solution: with large flange or split!
- + KRASO® Sealing Insert quality: 5 mm thick clamping plates made of non-corrosive stainless steel V2A, 30 or 60 mm seal made of a specially developed rubber mixture, welded-on studs instead of through bolts
- + Torque Control Nut KRASO® DKM: integrated torque limiter - no torque wrench required!
- + MPA-tested: protects reliably against pressing water up to 2.5 bar / 5 bar!
- + Gas- and odour-tight – high-quality in terms of TA-Air!
- + Radon tightness IAF tested - meets the requirements for radon precautionary areas according to FHRK leaflet MB 101!
- + Tested according to FHRK test specification GE 101!
- + With arrangement template: see the arrangement of media pipes, pipes and cables at a glance!
- + Generally available within 24 hours!
- + Available at an additional charge: stainless steel V4A / KTW - recommendation / NBR - oil- and petrol-resistant / temperature resistant up to 220 °C
- + DafStB waterproof concrete guideline: stress class 1 + 2

KRASO® Sealing Insert Type SD 30 • KRASO® Sealing Insert Type SD 60 **LG1**

for installation of pipes or cables, Torque Control Nut KRASO® DKM* | DafStB waterproof concrete guideline: stress class 1 + 2
KRASO® Type SD 30 / KRASO® Type SD 30 - T, split / KRASO® Type SD 30 - GF, large flange
KRASO® Type SD 60 / KRASO® Type SD 60 - T, split / KRASO® Type SD 60 - GF, large flange

Core drilling / casing in mm	50	60	70	80	100	125	150	200	250	300	350	400	450	500
(from - to)	(49 - 52)	(59 - 62)	(69 - 72)	(79 - 83)	(99 - 103)	(124 - 128)	(149 - 153)	(198 - 203)	(248 - 253)	(298 - 303)	(348 - 353)	(398 - 403)	(448 - 453)	(497 - 503)

max. external diameter pipe or cable

from	0	0	0	0	0	0	0	0	0	0	0	0	0	0
to	25	35	45	55	75	100	125	175	225	275	325	375	425	475

KRASO® Type SD 30

KRASO® Type SD 30	91 €	91 €	91 €	98 €	98 €	125 €	142 €	184 €	248 €	317 €	380 €	435 €	513 €	571 €
KRASO® Type SD 30 - T	105 €	105 €	105 €	113 €	113 €	144 €	163 €	212 €	285 €	364 €	437 €	500 €	590 €	656 €
KRASO® Type SD 30 - GF	100 €	100 €	100 €	108 €	108 €	138 €	156 €	202 €	272 €	348 €	418 €	478 €	564 €	628 €

Surcharge: additional drilling **up to 5 drillings each additional drilling 17 €, each further additional drilling 11 €**

KRASO® Type SD 60

KRASO® Type SD 60	122 €	131 €	131 €	131 €	140 €	172 €	202 €	261 €	339 €	444 €	516 €	575 €	680 €	795 €
KRASO® Type SD 60 - T	141 €	150 €	150 €	150 €	161 €	198 €	232 €	300 €	389 €	511 €	594 €	661 €	782 €	915 €
KRASO® Type SD 60 - GF	134 €	144 €	144 €	144 €	154 €	190 €	222 €	287 €	372 €	489 €	568 €	632 €	748 €	875 €

Surcharge: additional drilling **up to 5 drillings each additional drilling 17 €, each further additional drilling 11 €**

* In some cases, allen screws must be used due to the design

All sizes and diameters available on request!

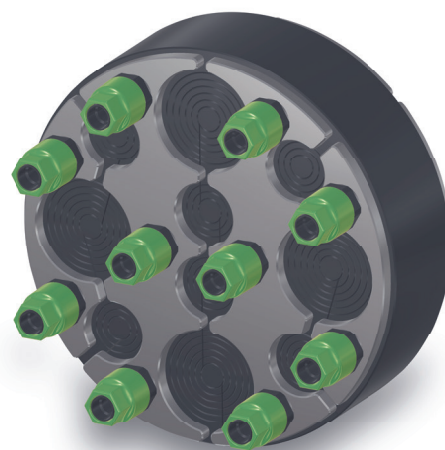
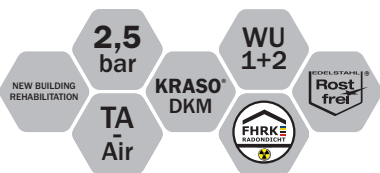

KRASO® Sealing Insert Universal Multiple - split - Universally usable – multiply flexible

- + For core drillings and casings
- + **Stepless onion ring technology: universally usable for various external diameters of media lines / cables - even with several drillings!** Split design for retrofit installation!
- + **KRASO® Sealing Insert quality: 5 mm thick clamping plates made of non-corrosive stainless steel V2A, 40 mm seal made of specially developed rubber mixture, welded-on studs instead of through bolts**
- + Torque Control Nut **KRASO® DKM: integrated torque limiter - no torque wrench required!**
- + **MPA-tested: protects reliably against pressing water up to 2.5 bar!**
- + **Gas- and odour-tight** – high-quality in terms of TA-Air!
- + **Radon tightness IAF tested** - meets the requirements for radon precautionary areas according to FHRK leaflet MB 101!
- + **DafStB waterproof concrete guideline: stress class 1 + 2**

Stepless onion ring technology!
example
KRASO® Sealing Insert Universal Multiple 150 - split - Design 1:
3 x 6 - 52 mm or blind

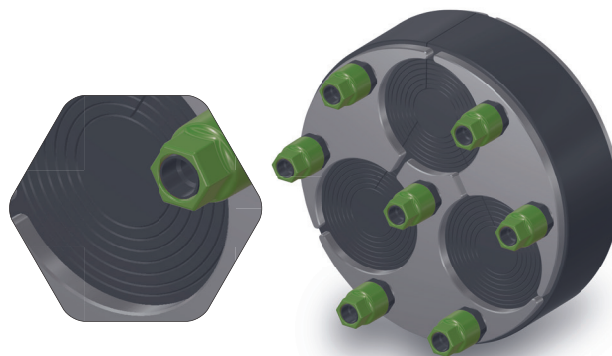

KRASO® Sealing Insert Universal Multiple - split - **LG 1**

for simultaneous installation of several media lines/cables, split design for retrofit installation | **DafStB waterproof concrete guideline: stress class 1 + 2**

Type / Item	KRASO® Sealing Insert Universal Multiple - split -			
Core drilling / casing in mm	100	125	150	200
	Stepless onion ring technology: external cable diameter from... to ... in mm			
Design 1	4 x 6 - 33 mm or blind	6 x 6 - 28 mm or blind	3 x 6 - 52 mm or blind	3 x 6 - 28 mm or blind 4 x 6 - 52 mm or blind
Design 2	3 x 6 - 18 mm or blind 2 x 6 - 33 mm or blind	-	4 x 6 - 18 mm or blind 6 x 6 - 33 mm or blind	7 x 6 - 18 mm or blind 8 x 6 - 33 mm or blind
Design 3	8 x 6 - 18 mm or blind	-	6 x 6 - 38 mm or blind	-
KRASO® Sealing Insert Universal Multiple - split -	95 €	103 €	145 €	225 €

Further arrangements available at short notice!



KRASO® Sealing Insert Type GR
Check the installation video
(just scan the QR code!)



Specially for
ribbed
media pipes



KRASO® Sealing Insert Type GR

The sealing insert for ribbed media pipes

- + For corrugated and ribbed pipes!
- + With a specially developed soft rubber seal – double sealing with 40 mm seal or quadruple sealing with 80 mm seal – and central pressure disk for even pressure distribution
- + **KRASO® Sealing Insert quality:** 5 mm thick clamping plates made of non-corrosive stainless steel V2A, more studs for even pressure distribution, welded-on studs instead of through bolts
- + Torque Control Nut **KRASO® DKM:** integrated torque limiter - no torque wrench required!
- + **MPA-tested:** protects reliably against pressing water up to 1 bar / 2 bar!
- + Gas- and odour-tight – high-quality in terms of TA-Air!
- + Radon tightness IAF tested - meets the requirements for radon precautionary areas according to FHRK leaflet MB 101!
- + Tested according to FHRK test specification GE 101!
- + DafStB waterproof concrete guideline: stress class 1 + 2



KRASO® Type DD/GR
ribbed media pipes



KRASO® Type VD/GR
ribbed media pipes

KRASO® Sealing Insert Type GR **LG 1**

for installation of ripped or corrugated media pipes | DafStB waterproof concrete guideline: stress class 1 + 2

Type / Item	KRASO® Type DD/GR • KRASO® Type VD/GR								
Core drilling / casing in mm (from - to)	100 (99 - 103)	125 (124 - 128)	150 (149 - 153)	200 (198 - 203)	250 (248 - 253)	300 (298 - 303)	350 (348 - 353)	400 (398 - 403)	500 (497 - 503)
max. external diameter pipe or cable from ... to ... in mm	0 - 75	0 - 100	0 - 125	0 - 175	0 - 225 ¹	0 - 275 ¹	0 - 325 ¹	0 - 375 ¹	0 - 475 ¹
KRASO® Type DD/GR (40 mm)	123 €	151 €	178 €	224 €	260 €	378 €	449 €	521 €	655 €
KRASO® Type VD/GR (80 mm)	155 €	189 €	224 €	281 €	326 €	474 €	558 €	647 €	814 €

¹ From 200 mm external diameter of pipe or cable: KRASO® Sealing Insert Type DD/GR with 60 mm seal

Further sizes and diameters available on request! All sealing inserts available in V4A for an additional charge!

NEW!
Internal sealing
for ribbed
media pipes



Stepless onion ring technology!
example
KRASO® Sealing Insert Type IN-GR®
DN 110: 1 x 5 - 18 mm, 1 x 5 - 38 mm

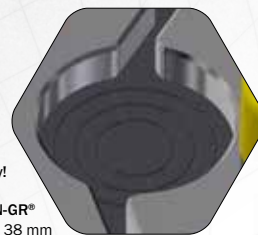

KRASO® Sealing Insert Type IN-GR® Inner seal for ribbed media pipes

- + Sealing insert for the internal sealing of one or several media lines in cable protective hoses type-R
- + Stepless onion ring technology: universally suitable for a wide range of external diameters of media lines/cables – even for multiple installation of media lines/cables! Split design for retrofit installation!
- + Torque Control Nut **KRASO® DKM**: integrated torque limiter - no torque wrench required!
- + Non-corrosive stainless steel V2A, 30 mm seal
- + **DafStB** waterproof concrete guideline: stress class 1 + 2

KRASO® Sealing Insert Type IN-GR® **LG 1**

Internal sealing insert for cable protective hoses Type-R/corrugated pipes for the installation of one or several media lines or cables | **DafStB** waterproof concrete guideline: stress class 1 + 2

Type / Item	KRASO® Type IN-GR®						
Corrugated pipe Diameter DN in mm (internal diameter in mm)	90 (75)	110 (92)	110 (92)	110 (92)	160 (136)	160 (136)	160 (136)
Stepless onion ring technology: external-diameter cable from ... to ... in mm	1 x 5 - 33 mm	1 x 5 - 48 mm	1 x 5 - 18 mm 1 x 5 - 38 mm	4 x 5 - 18 mm	3 x 5 - 43 mm	4 x 5 - 38 mm	6 x 5 - 33 mm
KRASO® Type IN-GR®	89 €	95 €	118 €	118 €	145 €	145 €	145 €

Further sizes and diameters available on request! All sealing inserts available in V4A for an additional charge!



10 bar!
For special tasks!



KRASO® Sealing Insert Type TD-X

The trio seal of a superior class

- + For core drillings or casings
- + 20% thicker steel plates made of non-corrosive stainless steel V2A!
- + Triple sealing with 60 mm seal made of specially developed sealing rubber!
- + Two circular pressure discs guarantee optimal pressure distribution!
- + More studs for even pressure distribution, welded-on studs instead of through bolts!
- + Torque Control Nut **KRASO® DKM**: integrated torque limiter - no torque wrench required!
- + MPA-tested: protects reliably against pressing water up to 10 bar!
- + Gas- and odour-tight – high-quality in terms of TA-Air!
- + Radon tightness IAF tested - meets the requirements for radon precautionary areas according to FHRK leaflet MB 101!
- + Tested according to FHRK test specification GE 101!
- + DafStB waterproof concrete guideline: stress class 1 + 2

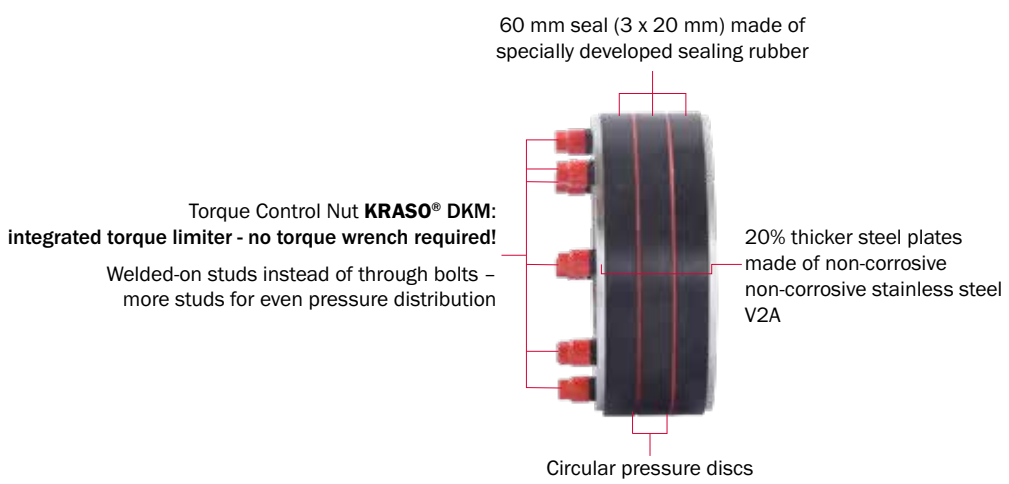

KRASO® Sealing Insert Type TD-X **LG1**

for installation of pipes | DafStB waterproof concrete guideline: stress class 1 + 2

Type / Item	KRASO® Type TD-X									
Core drilling / casing in mm (from - to)	80 (79 - 83)	100 (99 - 103)	125 (124 - 128)	150 (149 - 153)	200 (198 - 203)	250 (248 - 253)	300 (298 - 303)	350 (348 - 353)	400 (398 - 403)	500 (497 - 503)
max. external diameter pipe or cable from ... to ... in mm	0 - 55	0 - 75	0 - 100	0 - 125	0 - 175	0 - 225	0 - 275	0 - 325	0 - 375	0 - 475
KRASO® Type TD-X	127 €	143 €	167 €	200 €	264 €	318 €	469 €	589 €	709 €	1.004 €

* In some cases, allen screws must be used due to the design.

All sizes and diameters available on request! All sealing inserts available in V4A for an additional charge!



KRASO® Sealing Insert Type FIX **LG 1**

for installation of pipes, with mounting bracket for fixing to the wall, Torque Control Nut **KRASO®** DKM*, non-corrosive stainless steel V2A, single sealing, against pressing water up to 1 bar, 20 mm seal (**KRASO®** Type ED/FIX), double sealing, against pressing water up to 3 bar, 40 mm seal (**KRASO®** Type DD/FIX) | DafStB waterproof concrete guideline: stress class 1 + 2

Type / Item	KRASO® Type ED/FIX • KRASO® Type DD/FIX									
Core drilling / casing in mm (from - to)	80 (79 - 83)	100 (99 - 103)	125 (124 - 128)	150 (149 - 153)	200 (198 - 203)	250 (248 - 253)	300 (298 - 303)	350 (348 - 353)	400 (398 - 403)	500 (497 - 503)
max. external diameter pipe or cable from ... to ... in mm	0 - 55	0 - 75	0 - 100	0 - 125	0 - 175	0 - 225	0 - 275	0 - 325	0 - 375	0 - 475
KRASO® Type ED/FIX	64 €	70 €	84 €	100 €	131 €	160 €	234 €	294 €	354 €	503 €
KRASO® Type DD/FIX	96 €	108 €	126 €	150 €	198 €	239 €	351 €	442 €	533 €	754 €

* In some cases, allen screws must be used due to the design.

All sizes and diameters available on request! All sealing inserts available in V4A for an additional charge!

KRASO®
Sealing Insert
Type Blind ED + DD + VD
from DN 250 with inner core
to distribute the pressure:

- less installation weight
- easy installation
- perfect pressure distribution



KRASO® Type Blind ED 250



KRASO® Type Blind DD 250



KRASO® Type Blind VD 250



KRASO® Type Blind ED



KRASO® Type Blind DD



KRASO® Type Blind VD



KRASO® Sealing Insert Type Blind ED + DD + VD **LG 1**

blind plug, for pressing water, Torque Control Nut **KRASO®** DKM, non-corrosive stainless steel V2A, single sealing, against pressing water up to 1 bar, 20 mm seal (**KRASO®** Type Blind ED), double sealing, against pressing water up to 3 bar, 40 mm seal (**KRASO®** Type Blind DD), quadruple sealing, against pressing water up to 8 bar, 80 mm seal (**KRASO®** Type Blind VD), from DN 250 with central distribution plate: low installation weight, easier installation, optimal pressure distribution | DafStB waterproof concrete guideline: stress class 1 + 2

Type / Item	KRASO® Type Blind ED • KRASO® Type Blind DD • KRASO® Type Blind VD									
Core drilling / casing in mm (from - to)	80 (79 - 83)	100 (99 - 103)	125 (124 - 128)	150 (149 - 153)	200 (198 - 203)	250 (248 - 253)	300 (298 - 303)	350 (348 - 353)	400 (398 - 403)	500 (497 - 503)
KRASO® Type Blind ED (seal 20 mm)	56 €	62 €	76 €	85 €	117 €	138 €	180 €	196 €	211 €	304 €
KRASO® Type Blind DD (seal 40 mm)	67 €	77 €	95 €	112 €	141 €	164 €	238 €	283 €	328 €	411 €
KRASO® Type Blind VD (seal 80 mm)	84 €	96 €	118 €	140 €	176 €	205 €	297 €	353 €	410 €	514 €

Further diameters available on request! All sealing inserts available in V4A for an additional charge!



The
alternative
to a fixed-
loose flange!



KRASO® Foil Clamping Flange Type FKF

When “tight“ means simply tight –
sealing solutions for the “black tank“

- + Designers and building contractors face numerous **structural-physical conditions**. The **protection of below-ground structural elements against moisture and water** is regulated by **DIN 18533**, stating different water exposure class and provisions regarding the waterproofing of buildings.
- + For the sealing of utility lines in regard to buildings with exterior sealing (“black tank“) we offer our **KRASO® Casing Type FL** with fixed-loose flange construction according **DIN 18533 W1-E** or **W2-E**.
- + According to **DIN 18533**, the **KRASO® Foil Clamping Flange Type FKF** is an effective alternative for the integration of media lines into the sealing of larger areas.

Your advantages

- + Cost-effective, saves time and money
- + **Test-certificate from material testing institute in NRW: water pressure tight up to 2.5 bar**
- + **We are able to adjust the type of sealing sheets or foils individually**
- + Noticeable lower weight than a fixed-loose flange construction, for an easier installation, helps to avoid installation errors
- + **Suitable for every external diameter of media lines and all kinds of materials**
- + Metal components made of non-corrosive stainless steel V2A
- + For new buildings and rehabilitation!



KRASO® Foil Clamping Flange Type FKF
Check the installation video
(just scan the QR code!)

The alternative to a fixed-loose flange!



SEALING INSERTS

KRASO® Foil Clamping Flange Type FKF

The revolution in terms of the integration of media lines into the sealing of larger areas

- + Innovative: water pressure tight sealing of any even and stable cable with our **KRASO®** Foil Clamping Flange Type FKF foil flange!
- + Suitable for all external diameters of media lines and for all materials!
- + We can individually customise the type of sealing sheets or foils:
e.g. PVC, EPDM, FPO, RESITRIX®, PP, PE, **KRASO®**-Fol, PYE-PV 200 S5 etc.
- + Torque Control Nut **KRASO®** DKM: integrated torque limiter - no torque wrench required!
- + Metal components made of non-corrosive stainless steel V2A
- + For new buildings and rehabilitation! Various designs for almost every situation!
- + Simple and fast mounting!
- + MPA-tested: water pressure tight up to 2.5 bar!
- + Tested according to FHRK test specification GE 101!
- + DIN 18533 W1 -E and W2.1 -E

Included in the scope of supply

- **KRASO®** PU 50 - high-quality sealant
- pressure roller
- serrated spatula
- pencil for marking



KRASO® Foil Clamping Flange Type FKF - in front of the wall -



KRASO® Foil Clamping Flange Type FKF - in front of the wall - split -



KRASO® Foil Clamping Flange Type FKF - in the core drilling -



KRASO® Foil Clamping Flange Type FKF - in the core drilling - split -

KRASO® Foil Clamping Flange Type FKF **LG 1**

for the sealing of media of all kinds of materials in front of a wall or in the core drilling, with foil flange 1.2 mm, according to DIN 16937, oil- and bitumen resistant, surrounding approx. 15 cm, 30 mm seal | **DIN 18533 W1 -E and W2.1 -E**

Core drilling / casing in mm	max. external diameter pipe or cable from ... to ... in mm	KRASO®			
		Foil Clamping Flange Type FKF - in front of the wall -	Foil Clamping Flange Type FKF - in front of the wall - split -	Foil Clamping Flange Type FKF - in the core drilling -	Foil Clamping Flange Type FKF - in the core drilling - split -
80 (79 - 83)	0 - 40	219 €	297 €	219 €	241 €
100 (99 - 103)	0 - 63	231 €	332 €	231 €	254 €
125 (124 - 128)	0 - 80	265 €	377 €	265 €	291 €
150 (149 - 153)	0 - 110	321 €	446 €	321 €	354 €
200 (198 - 203)	0 - 160	402 €	561 €	402 €	441 €
250 (248 - 253)	0 - 200	548 €	783 €	548 €	602 €
300 (298 - 303)	0 - 250	753 €	1.022 €	753 €	828 €

Scope of supply: **KRASO®** Foil Clamping Flange Type FKF, adhesive and sealant **KRASO®** PU 50, serrated spatula, pressure roller and pencil
Further sizes and diameters available on request! Also available with other sealing sheets!



KRASO® Foil Clamping Flange Type FKF DD/GR **LG1**

for the sealing of media of all kinds of material in front of a wall or in the core drilling, with foil flange 1.2 mm, according to DIN 16937, oil- and bitumen resistant, surrounding approx. 15 cm, 40 mm specially soft seal, central pressure distribution plate for even pressure distribution with corrugated media pipes, against pressing water up to 1 bar, Torque Control Nut **KRASO®** DKM, non-corrosive stainless steel V2A | **DIN 18533 W1 -E and W2.1 -E**

Core drilling / casing in mm	(from - to)	max. external diameter pipe or cable from ... to ... in mm	KRASO®	KRASO®	KRASO®	KRASO®
			Foil Clamping Flange Type FKF DD/GR - in front of the wall -	Foil Clamping Flange Type FKF DD/GR - in front of the wall - split -	Foil Clamping Flange Type FKF DD/GR - in the core drilling -	Foil Clamping Flange Type FKF DD/GR - in the core drilling - split -
100	(99 - 103)	0 - 63	311 €	426 €	311 €	331 €
125	(124 - 128)	0 - 80	357 €	491 €	357 €	378 €
150	(149 - 153)	0 - 110	434 €	595 €	434 €	457 €
200	(198 - 203)	0 - 160	542 €	745 €	542 €	571 €
250	(248 - 253)	0 - 200 ¹	739 €	1.016 €	739 €	833 €
300	(298 - 303)	0 - 250 ¹	1.017 €	1.397 €	1.017 €	1.098 €

¹ From 200 mm external diameter of the pipe or cable: **KRASO®** Foil Clamping Flange Type FKF DD/GR with 60 mm seal

Scope of supply: **KRASO®** Foil Clamping Flange Type FKF DD/GR, adhesive and sealant **KRASO®** PU 50, serrated spatula, pressure roller and pencil
Further sizes and diameters available on request! Also available with other sealing sheets!



KRASO® Foil Clamping Flange Type FKF Universal **LG1**

for the sealing of media of all kinds of materials in front of the wall or in the core drilling, with foil flange 1.2 mm, according to DIN 16937, oil- and bitumen resistant, surrounding approx. 15 cm, 40 mm seal, against pressing water up to 1.5 bar, Torque Control Nut **KRASO®** DKM, non-corrosive stainless steel V2A | **DIN 18533 W1 -E and W2.1 -E**

External diameter or core drilling in mm	KRASO® Foil Clamping Flange Type FKF Universal 100	KRASO® Foil Clamping Flange Type FKF Universal 150	KRASO® Foil Clamping Flange Type FKF Universal 200
A sealing insert for all pipes or cables listed in the table on the right (in mm)	stepless onion ring technology: 18 - 65 mm or blind	110 (DN 110 KG pipe) (DN 110 SML pipe)	160 (DN 160 KG pipe) (DN 160 SML pipe)
		90 (DN 80 steel pipe, PE pipe)	135 (DN 125 SML pipe)
		75 (DN 70 HT pipe)	125 (DN 125 KG pipe)
		0	110 (DN 110 KG pipe) (DN 110 SML pipe)
			0
KRASO® Foil Clamping Flange Type FKF Universal - in the core drilling -	203 €	277 €	339 €
KRASO® Foil Clamping Flange Type FKF Universal - in front of the wall -	203 €	277 €	339 €

Scope of supply: **KRASO®** Foil Clamping Flange Type FKF Universal, adhesive and sealant **KRASO®** PU 50, serrated spatula, pressure roller and pencil
Further sizes and diameters available on request! Also available with other sealing sheets!



KRASO® Plastic Flange Plate Type KFP - split -
Check the installation video
(just scan the QR code!)

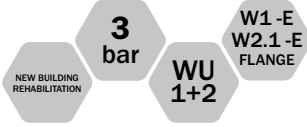

KRASO® Plastic Flange Plate Type KFP - split - A proven solution reinvented

- + Like a „split casing“: the flange plate made of **high-strength special plastic** can be installed **retrospectively**.
- + **No core drilling**: no need for the separation of media pipes for installation!
- + Installation in front of a **wall made of waterproof concrete (WU)** or as **KRASO® Type KFP with foil flange** in front of a wall with **sealing of larger areas**.
- + **Easy installation by just one person** thanks to the low weight!
- + Latest CNC production technology: **absolute dimensional compliance** – no tolerances like they are usual with solutions involving metal.
- + **Tongue and groove system**: the two halves of the plastic flange plate pull together with 100% accurate fit automatically. **Installation errors are thus avoided due to this innovation!**
- + Subsequent sealing of the media lines in the plastic flange plate using **KRASO® Sealing Insert**.
- + **DafStB waterproof concrete guideline: stress class 1 + 2**, with foil flange **DIN 18533 W1 -E and W2.1 -E**



KRASO® Plastic Flange Plate
Type KFP - split -



KRASO® Plastic Flange Plate
Type KFP - Foil Flange - split -

KRASO® Plastic Flange Plate Type KFP - split - **LG1**

for installation of pipes or cables using a sealing insert (not included in the scope of supply), ID = InternalDiameter | **DafStB waterproof concrete guideline: stress class 1 + 2**, with foil flange **DIN 18533 W1 -E and W2.1 -E**

Type / Item	KRASO® Type KFP - split - • KRASO® Type KFP - Foil Flange - split						
InternalDiameter ID	80	100	125	150	200	250	300
max. external diameter pipe or cable from ... to ... in mm	0 - 55	0 - 75	0 - 100	0 - 125	0 - 175	0 - 225	0 - 275
Plate size approx. in mm	d = 240	d = 260	d = 285	d = 310	d = 360	d = 410	d = 460
KRASO® Plastic Flange Plate Type KFP - split -	363 €	374 €	403 €	422 €	488 €	556 €	613 €
KRASO® Plastic Flange Plate Type KFP - Foil Flange - split	454 €	469 €	505 €	527 €	611 €	696 €	765 €

Scope of supply: KRASO® Plastic Flange Plate Type KFP - split - or KRASO® Plastic Flange Plate Type KFP - Foil Flange - split -, EPDM flat seal to the component and fixing material, adhesive and sealant **KRASO® PU 50**

Further sizes and diameters available on request!



KRASO® Plastic Flange Plate Type KFP - Foil Flange

KRASO® Plastic Flange Plate Type KFP

The flange plate made of high-strength special plastic

- + Due to changes in the groundwater level the rehabilitation of old buildings and the sealing of basements become necessary from time to time. Existing pipes and cables should also be sealed using the latest technology.
- + The sealing of the media lines inside the plastic flange is completed by using a split sealing insert.
- + DafStB waterproof concrete guideline: stress class 1 + 2, with foil flange DIN 18533 W1 -E and W2.1 -E

KRASO® Plastic Flange Plate Type KFP **LG 1**

for installation of pipes or cables using a sealing insert (not included in the scope of supply), no core drilling required, EPDM flat seal, ID = Internal-Diameter | DafStB waterproof concrete guideline: stress class 1 + 2, with foil flange DIN 18533 W1 -E and W2.1 -E

Type / Item	KRASO® Type KFP • KRASO® Type KFP - Foil Flange						
InternalDiameter ID	80	100	125	150	200	250	300
max. external diameter pipe or cable from ... to ... in mm	0 - 55	0 - 75	0 - 100	0 - 125	0 - 175	0 - 225	0 - 275
Plate size approx. in mm	d = 240	d = 260	d = 285	d = 310	d = 360	d = 410	d = 460
KRASO® Plastic Flange Plate Type KFP	259 €	268 €	288 €	302 €	349 €	398 €	439 €
KRASO® Plastic Flange Plate Type KFP - Foil Flange	325 €	334 €	360 €	378 €	438 €	496 €	548 €

Scope of supply: KRASO® Plastic Flange Plate Type KFP or KRASO® Plastic Flange Plate Type KFP - Foil Flange, EPDM flat seal to the component and fixing material, adhesive and sealant KRASO® PU 50

Further sizes and diameters available on request!

KRASO® KFP Installation kit

suitable for KRASO® Plastic Flange Plate Type KFP: KRASO® Torque Wrench, socket wrench insert 8, Ø 19 mm nut, cartridge pressing pistol, blower for drilled holes



A proven
solution
reinvented!

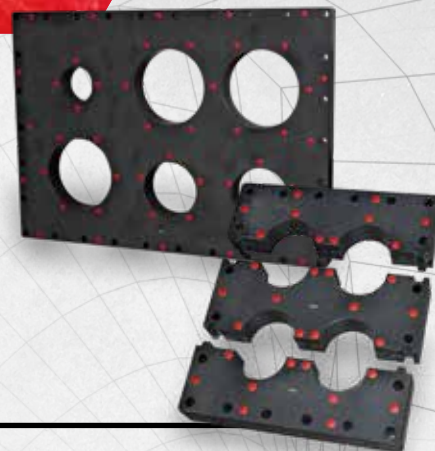

KRASO® Plastic Flange Plate Type KFP - multiple / multiple split

- + The flange plate made of high-strength special plastic can be installed retrospectively.
- + Installation in front of a wall made of waterproof concrete (WU) or in front of a wall with sealing of larger areas.
- + Subsequent sealing of the media pipes in the plastic flange plate using a sealing insert.

You build -
we seal!

KRASO® Installation Service

- + Whether new building or rehabilitation: the **KRASO®** Installation Service helps you with sealing your construction-site. Our team will be happy to support you from measurement to installation. Our technicians develop a solution and our mechanics deal with the installation on-site.

We are looking forward to your enquiry:

- + +49(0)28 72 - 95 35-0
- + WhatsApp +49(0)28 72 - 95 35-888 
- + export@kraso.de





KRASO® Multi-Flange Plate Type MFP
Check the installation video
(just scan the QR code!)

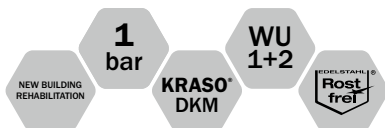

KRASO® Multi-Flange Plate Type MFP

Smart combination – innovative solution

- + Combination of high-quality **KRASO® Sealing Insert** and flange plate made of high-strength special plastic!
- + Fast and easy installation thanks to the low weight – even by just one person!
- + Installation in front of the waterproof (WU) concrete wall. EPDM flat seal, fixing material and adhesive and sealant **KRASO® PU 50** are included in the scope of supply.
- + For new buildings and rehabilitation! All kinds of media lines can also be installed or sealed retrospectively - easy and fast. Special designs can usually be produced and dispatched within 24 hours.
- + MPA-tested: water pressure tight up to 1 bar!
- + Torque Control Nut **KRASO® DKM**: integrated torque limiter - no torque wrench required!
- + DafStB waterproof concrete guideline: stress class 1 + 2



KRASO® Multi-Flange Plate Type MFP, EPDM flat seal, fixing material, adhesive and sealant **KRASO® PU 50**

KRASO® Multi-Flange Plate Type MFP **LG 1**

for installation of pipes, sealing width to the media pipe or cable 20 mm | DafStB waterproof concrete guideline: stress class 1 + 2

Type / Item	KRASO® Multi-Flange Plate Type MFP						
Diameter integrated KRASO® Sealing Insert	80	100	125	150	200	250	300
Plate size approx. in mm	d = 206	d = 226	d = 243	d = 273	d = 323	d = 373	d = 423
Diameter pipe or cable from ... to ... in mm	22 - 25	32 - 35	60 - 63	78 - 80	108 - 110	158 - 160	200
	32 - 35	40 - 43	75 - 77	88 - 90	114 - 118	168 - 170	210
	40 - 43	48 - 50	78 - 80	108 - 110	123 - 125	177 - 180	219
		60 - 63			133 - 135	200	225
					139 - 140	210	250
				158 - 160			
KRASO® Multi-Flange Plate Type MFP	213 €	225 €	244 €	261 €	315 €	361 €	444 €

Scope of supply: KRASO® Multi-Flange Plate Type MFP, EPDM flat seal incl. fixing material, adhesive and sealant **KRASO® PU 50**

Further sizes and diameters available on request!



KRASO® Casing Type FL/ZA
for dowel-fixing - non-corrosive stainless steel - with special coating

- threaded protective caps protect the threaded bolts against contamination with thick coating
- spacers prevent the thick coating from being pressed off

KRASO® Casing and Sealing Insert Type FL

Fixed-loose flange for dowel-fixing or for concreting and as a sealing insert

- + For buildings with exterior sealing (“black tank”): according to DIN 18533 (“sealing of below-ground structural elements“)
- + Each design available as separate **types for pressing and non-pressing water**
- + Available in non-corrosive stainless steel V2A or V4A and in electrogalvanised steel
- + Upon request available with special coating for buildings with thick coating (e.g. KMB)!
- + **DIN 18533: water exposure classes W2.1 -E and W2.2 -E** (“medium impact of pressing water“ (water column ≤ 3 metres)“ / „high impact of pressing water (water column ≥ 3 metres)“)



KRASO® Casing Type FL/ZA
- for dowel-fixing -



non-corrosive stainless steel V2A

KRASO® Casing Type FL/ZE
- for concreting -



non-corrosive stainless steel V2A

KRASO® Sealing Insert Type FL/DD
- double sealing -



non-corrosive stainless steel V2A



electrogalvanised



electrogalvanised,
with plastic casing



electrogalvanised



KRASO® Casing Type FL/ZA
Check the installation video
(just scan the QR code!)

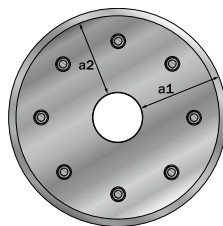

Schematic top view



KRASO® Casing Type FL/ZA - fixed-loose flange for dowel-fixing **LG 2**

fixed-loose flange for dowel-fixing, with casing, for installation of media pipes using a sealing insert (not included in the scope of supply), for buildings with exterior sealing ("black tank") according to DIN 18533. Available in non-corrosive stainless steel V2A or electrogalvanised, each with or without special coating. ID = InternalDiameter | **DIN 18533 W2.1 -E and W2.2 -E**

Type / Item	KRASO® Casing Type FL/ZA - DIN 18533 W2.2 -E: HIGH IMPACT OF PRESSING WATER (WATER COLUMN ≥ 3 METRES)						
Casing Internal Diameter ID	80	100	125	150	200	250	300
Protrusion in mm	80						
Diameter fixed-flange a1	surrounding 160 mm - t = 10 mm						
Diameter loose -flange a2	surrounding 150 mm - t = 10 mm						
KRASO® Casing Type FL/ZA - non-corrosive stainless steel V2A -	766 €	863 €	931 €	1.045 €	1.262 €	1.486 €	1.737 €
KRASO® Casing Type FL/ZA - electrogalvanised -	546 €	616 €	671 €	747 €	884 €	1.085 €	1.332 €
EPDM supplement (2 pcs.)	32 €	35 €	39 €	44 €	58 €	75 €	86 €
Surcharge special coating	144 €	151 €	166 €	183 €	201 €	222 €	243 €

Type / Item	KRASO® Casing Type FL/ZA - DIN 18533 W2.1 -E: MEDIUM IMPACT OF PRESSING WATER (WATER COLUMN ≤ 3 METRES)						
Diameter fixed-flange a1	surrounding 70 mm - t = 6 mm						
Diameter loose -flange a2	surrounding 60 mm - t = 6 mm						
KRASO® Casing Type FL/ZA - non-corrosive stainless steel V2A -	514 €	603 €	650 €	751 €	939 €	1.181 €	1.423 €
KRASO® Casing Type FL/ZA - electrogalvanised -	384 €	448 €	499 €	585 €	730 €	907 €	1.142 €
EPDM supplement (2 pcs.)	22 €	23 €	28 €	30 €	39 €	53 €	61 €
Surcharge special coating	122 €	129 €	135 €	142 €	149 €	157 €	164 €

Scope of supply: KRASO® Casing Type FL/ZA, casing with welded fixed-flange, loose-flange, dowels M8 x 100, bolts, nuts and washers M20 /M12

Further diameters and protrusions available on request! Also available in V4A!





KRASO® Casing Type FL/ZE
Check the installation video
(just scan the QR code!)

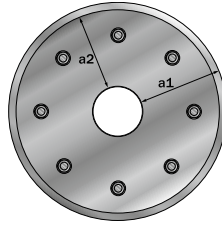

Schematic top view



KRASO® Casing Type FL/ZE - fixed-loose flange for concreting **LG 2**

fixed-loose flange for concreting, with casing, for installation of media pipes using a sealing insert (not included in the scope of supply) for buildings with exterior sealing ("black tank") against pressing /non-pressing water according to DIN 18533. Available in non-corrosive stainless steel V2A or electrogalvanised with plastic casing, each with or without special coating. ID = InternalDiameter | **DIN 18533 W2.1 -E and W2.2 -E**

Type / Item	KRASO® Casing Type FL/ZE - DIN 18533 W2.2 -E: HIGH IMPACT OF PRESSING WATER (WATER COLUMN ≥ 3 METRES)						
Casing Internal Diameter ID	80	100	125	150	200	250	300
Standard wall thicknesses in cm	20 • 24 • 25 • 30 • 35 • 36,5 • 40 • 45 • 50						
Diameter fixed-flange a1	surrounding 160 mm - t = 10 mm						
Diameter loose -flange a2	surrounding 150 mm - t = 10 mm						
KRASO® Casing Type FL/ZE - non-corrosive stainless steel V2A -	839 €	918 €	997 €	1.121 €	1.400 €	1.722 €	2.036 €
KRASO® Casing Type FL/ZE - electrogalvanised -	587 €	642 €	698 €	785 €	980 €	1.206 €	1.425 €
EPDM supplement (2 pcs.)	32 €	35 €	39 €	44 €	58 €	75 €	86 €
Surcharge special coating	144 €	151 €	166 €	183 €	201 €	222 €	243 €

Type / Item	KRASO® Casing Type FL/ZE -DIN 18533 W2.1 -E: MEDIUM IMPACT OF PRESSING WATER (WATER COLUMN ≤ 3 METRES)						
Diameter fixed-flange a1	surrounding 70 mm - t = 6 mm						
Diameter loose -flange a2	surrounding 60 mm - t = 6 mm						
KRASO® Casing Type FL/ZE - non-corrosive stainless steel V2A -	622 €	679 €	759 €	874 €	1.169 €	1.666 €	2.036 €
KRASO® Casing Type FL/ZE - electrogalvanised -	436 €	476 €	531 €	612 €	818 €	1.166 €	1.283 €
EPDM supplement (2 pcs.)	22 €	23 €	28 €	30 €	39 €	53 €	61 €
Surcharge special coating	122 €	129 €	135 €	142 €	149 €	157 €	164 €

Scope of supply: KRASO® Casing Type FL/ZE, with welded fixed-flange, loose-flange, dowels M8 x 100, bolts, nuts and washers M20 or M12

Further diameters and wall thicknesses available on request! Also available in V4A!



KRASO® Sealing Insert Type FL
Check the installation video
(just scan the QR code!)

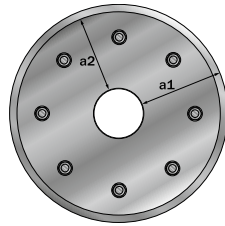

Schematic top view



KRASO® Sealing Insert Type FL - fixed-loose flange **LG 2**

fixed-loose flange with **KRASO®** Sealing Insert, for installation of media pipes for buildings with exterior sealing ("black tank") according to DIN 18533. Available in non-corrosive stainless steel V2A or electrogalvanised, each with or without special coating, Torque Control Nut **KRASO®** DKM | DIN 18533 W2.1 -E and W2.2 -E

Diameter DN	80	100	125	150	200	250	300
max. external diameter pipe or cable							
from	0	0	0	0	0	0	0
to	55	75	100	125	175	225	275

Type / Item	KRASO® Sealing Insert Type FL/DD - DIN 18533 W2.2 -E: HIGH IMPACT OF PRESSING WATER (WATER COLUMN ≥ 3 METRES)						
Diameter fixed-flange a1	surrounding 160 mm - t = 10 mm						
Diameter loose -flange a2	surrounding 150 mm - t = 10 mm						
KRASO® Sealing Insert Type FL/DD - non-corrosive stainless steel V2A -	779 €	876 €	954 €	1.063 €	1.258 €	1.543 €	1.900 €
KRASO® Sealing Insert Type FL/DD - electrogalvanised -	546 €	616 €	671 €	747 €	884 €	1.085 €	1.332 €
EPDM supplement (2 pcs.)	32 €	35 €	39 €	44 €	58 €	75 €	86 €
Surcharge special coating	144 €	151 €	166 €	183 €	201 €	222 €	243 €

Type / Item	KRASO® Sealing Insert Type FL/ED -DIN 18533 W2.1 -E: MEDIUM IMPACT OF PRESSING WATER (WATER COLUMN ≤ 3 METRES)						
Diameter fixed-flange a1	surrounding 70 mm - t = 6 mm						
Diameter loose -flange a2	surrounding 60 mm - t = 6 mm						
KRASO® Sealing Insert Type FL/ED - non-corrosive stainless steel V2A -	550 €	639 €	711 €	833 €	1.038 €	1.293 €	1.632 €
KRASO® Sealing Insert Type FL/ED - electrogalvanised -	384 €	448 €	499 €	585 €	730 €	907 €	1.143 €
EPDM supplement (2 pcs.)	22 €	23 €	28 €	30 €	39 €	53 €	61 €
Surcharge special coating	122 €	129 €	135 €	142 €	149 €	157 €	164 €

Scope of supply: KRASO® Sealing Insert Type FL/DD / KRASO® Sealing Insert Type FL/ED, sealing insert with welded fixed-flange, loose-flange, dowels M8 x 100, bolts, nuts and washers M20 or M12, 40 mm or 20 mm seal

Further diameters available on request! Also available in V4A!



KRASO® Flange Plate - non-corrosive stainless steel V2A **LG2**

for installation of pipes or cables using a sealing insert (not included in the scope of supply), in front of a core drilling in concrete or masonry wall, made of non-corrosive stainless steel V2A, EPDM flat seal. ID = InternalDiameter | **DafStB waterproof concrete guideline: stress class 1 + 2**

Type / Item	KRASO® Flange Plate non-corrosive stainless steel V2A						
InternalDiameter ID tubular sleeve	80	100	125	150	200	250	300
Protrusion in mm	80	80	80	80	80	80	80
Plate size in mm	d = 240	d = 260	d = 290	d = 310	d = 360	d = 410	d = 460
KRASO® Flange Plate - non-corrosive stainless steel V2A	228 €	236 €	252 €	265 €	308 €	348 €	384 €

Scope of supply: KRASO® Flange Plate non-corrosive stainless steel V2A, with welded stainless steel tubular sleeve, EPDM flat seal incl. fixing material and adhesive and sealant **KRASO® PU 50**

Further sizes and diameters available on request! Available for an additional charge: split design, fixed-loose flange construction according to DIN 18533, stainless steel V4A!



KRASO® Flange Plate - electrogalvanised **LG2**

for installation of pipes or cables using a sealing insert (not included in the scope of supply), in front of a core drilling in concrete or masonry wall, electrogalvanised steel, with welded tubular sleeve, EPDM flat seal. ID = InternalDiameter | **DafStB waterproof concrete guideline: stress class 1 + 2**

Type / Item	KRASO® Flange Plate electrogalvanised						
InternalDiameter ID tubular sleeve	80	100	125	150	200	250	300
Protrusion in mm	80	80	80	80	80	80	80
Plate size in mm	d = 240	d = 260	d = 290	d = 310	d = 360	d = 410	d = 460
KRASO® Flange Plate - electrogalvanised	171 €	177 €	190 €	199 €	230 €	262 €	289 €

Scope of supply: KRASO® Flange Plate electrogalvanised, EPDM flat seal incl. fixing material and adhesive and sealant **KRASO® PU 50**

Further sizes and diameters available on request!

stainless steel or galvanised?

Non-corrosive steel or galvanised?

Note the following:

- + **Long-lasting quality:** non-corrosive stainless steel has got an especially high proportion of chromium. Combined with further alloying constituents, this is a protective layer ("chromium-oxide") providing a special protection against corrosion and acids.
- + **Cost-effective alternative:** electrogalvanised steel has got a protective coating made of zinc. However, the coating is only a few microns. If this is damaged e.g. on the construction-site, the risk of corrosion increases. If there is constant dampness, it is advisable to use the quality of non-corrosive steel.





KRASO®
Sealing Inserts
 – protection
 against
 radon!



Rn
 Radon-tight

- + Radon is a naturally occurring noble gas. An accumulation of the radioactive gas in rooms is harmful to health!
- + **KRASO® Sealing Inserts** and **KRASO® Pipe Penetrations with 4 Seal** do not only protect against pressing water, but they are also gas-tight – MPA- and IAF-tested! **For a reliable protection against radon, look out for the label „RADON-TIGHT!“ and the „FHRK Radon Tight“ seal!**



KRASO®
Sealing Insert
Configurator
 – online and
 as app



- + **Simple and fast: configure the fitting sealing insert and request an offer online or via app. Just enter the quantity and diameters of the media lines and the sealing insert configurator proves the feasibility or proposes the suitable diameter for a core drilling.**

Available free of charge for Android and iOS or at [KRASO.de/en](https://www.kraso.de/en).



KRASO® Sealing Insert Configurator
 (just scan the QR code!)



Utility Connection -
Entries

Floor

Builder's Convenience Box - floor (p. 34) + Builder's Convenience Box - floor - 5-fold (p. 37) +
Builder's Convenience Box - floor - 110 (p. 38) + Builder's Convenience Box - floor - 150 (p. 41) +
Builder's Convenience Box - floor - NFE - Basis (p. 42)

Wall

Builder's Convenience Box - wall (p. 45) + Builder's Convenience Box - wall - NFE (p. 47) +
Builder's Convenience Box - wall - ESH (p. 49) + Builder's Convenience Box - wall - SWP (p. 51) +

Accessories

BKP - Sealing Inserts (p. 53) + BKP Floor Screed Insert (p. 53) + BKP gas installation kits (p. 54) +
BKP - wall - NFE - extension set (p. 54) + FLS 90 - Flexible Empty Pipe System (p. 54) +



KRASO® Builder's Convenience Box - floor
Check the installation video
(just scan the QR code!)

Multi utility
connection
for buildings
without
basement

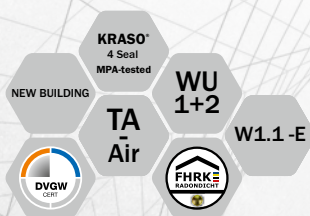
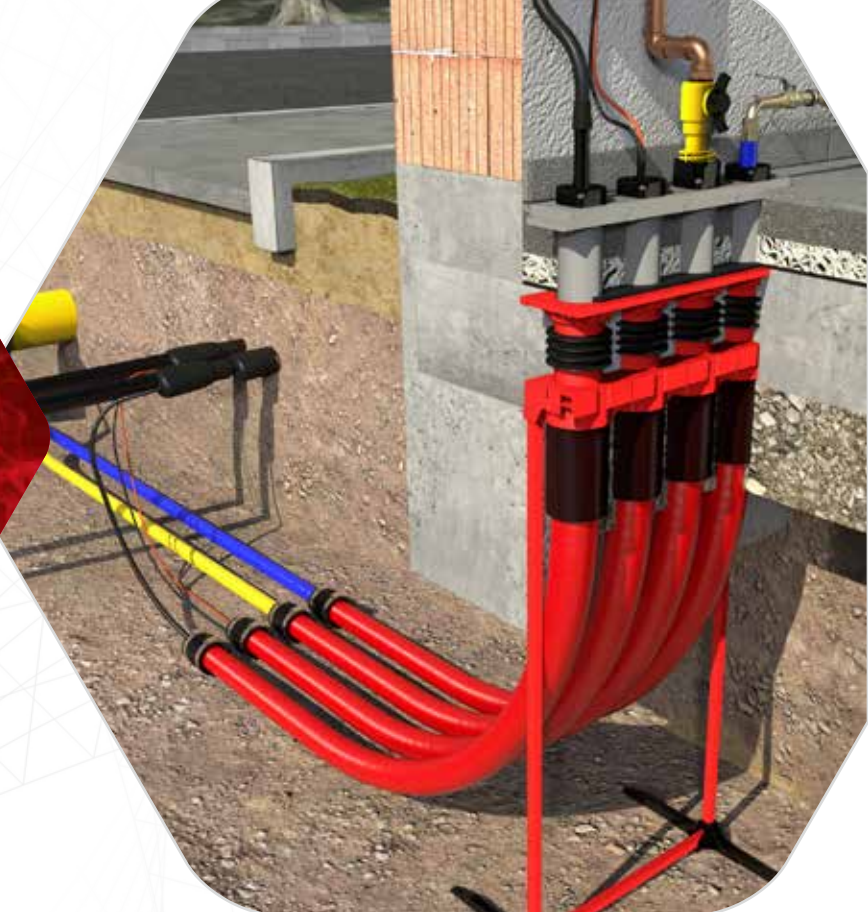

KRASO® Builder's Convenience Box - floor

The multi utility connection for
gas, water, electricity, telecommunication

- + The convenient solution for builders: **safe and tight installation of gas, water, electricity and telecommunication lines into buildings without basement!**
- + • **DVGW-certified according to VP 601:**
 - complete system is gas- and water pressure tight up to 1 bar!
 - Gas- and odour-tight – high-quality in terms of TA-Air!
 - Radon-tight! Resistant to methane gas!
 - **KRASO® 4 Seal** : exterior sealing of concrete: 10 bar!
- Overall system is gas- and water pressure tight up to 1 bar!
- + **Simple installation** due to stable installation device and visual check of the snap-on-socket - helps to avoid installation errors!
- + Hose diameter: **external 90 mm - internal 80 mm!**
- + For flush-mount installation in the base plate - no tripping hazards, no wall damages! Including building period installation cover.
- + **Easy integration of vapour barrier foils** due to the **roughened trowel flange!**
- + **Height-adjustable** base plate as well as floor screed.
- + **Optionally available KRASO® BKP Gas Installation Kits:**
 - gas utility connection Schuck DN 25
 - gas utility connection RMA DN 25
 - gas utility connection Voigt DN 25
 - gas utility connection Voigt DN 32
- + Split end plugs for easy installation!
- + Including extension set!
- + DafStB waterproof concrete guideline: stress class 1 + 2, DIN 18533 W1.1 - E

Internal
diameter
80 mm!



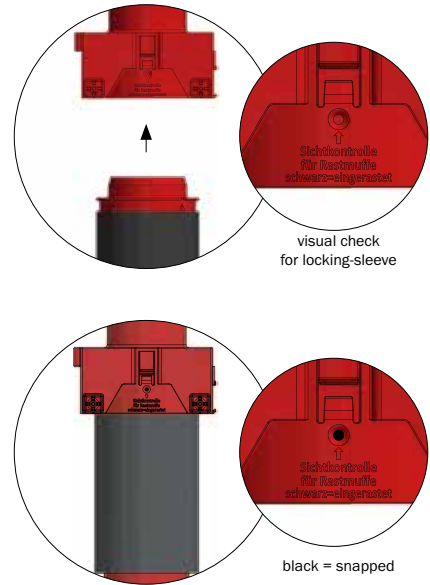
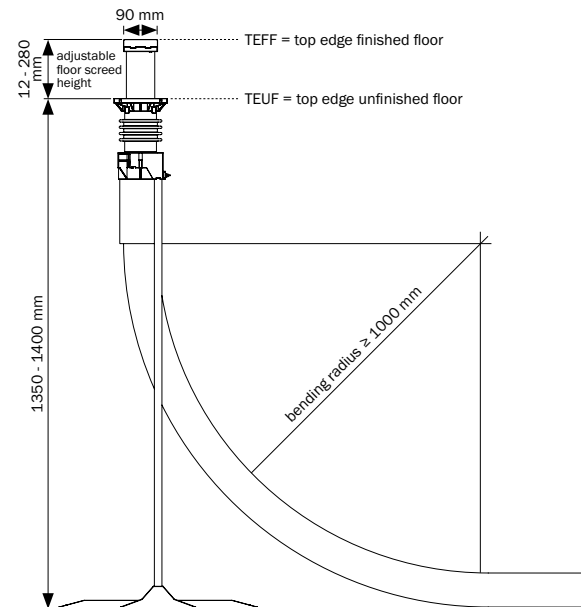
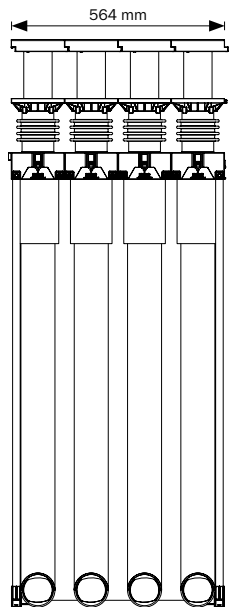
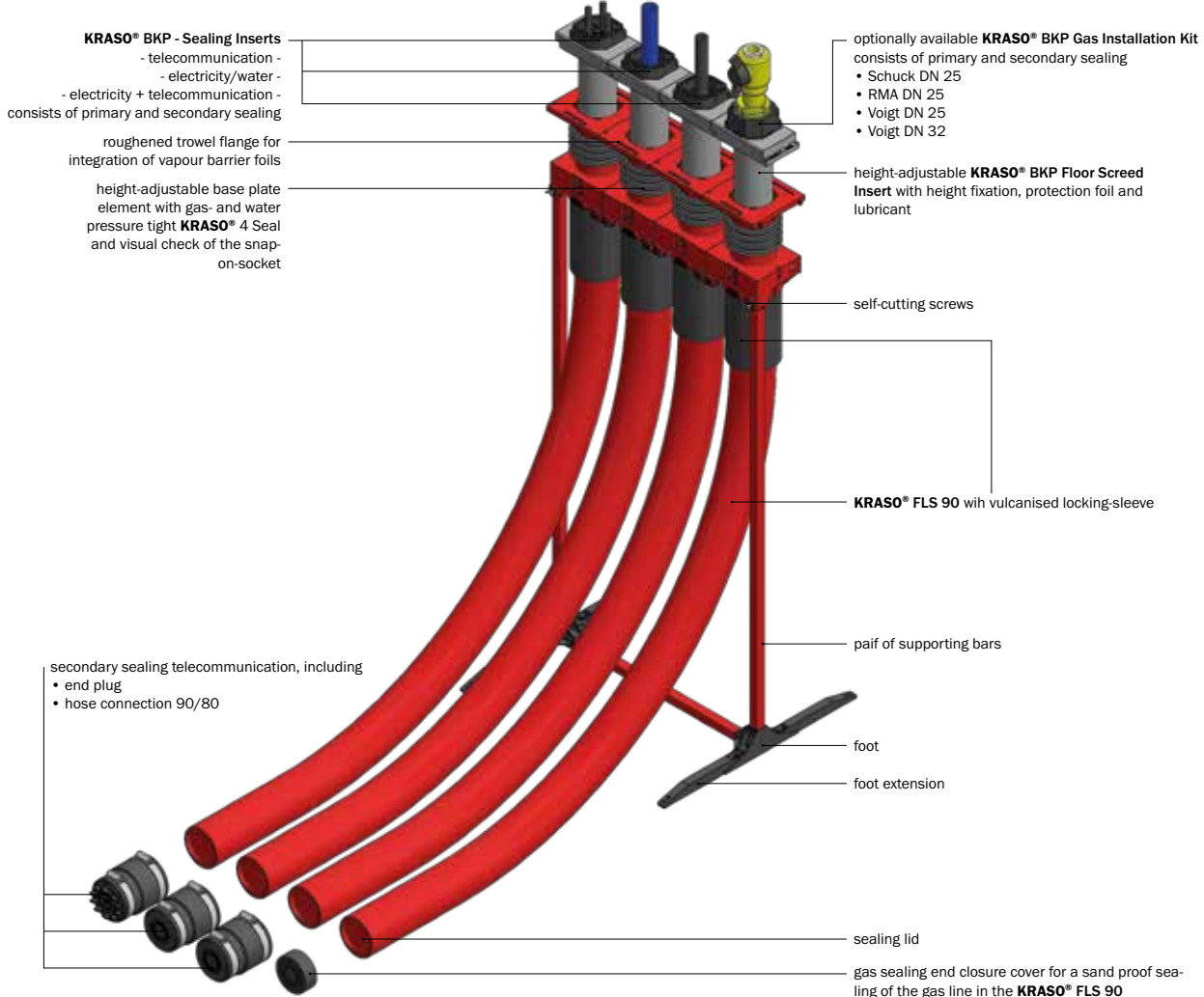

KRASO® BKP - floor - extension set

as an extension for the Flexible Empty Pipe System **KRASO® FLS 90** with on-site provided cable protective hose, including 2 x shrink hose 95/25 and 1 x adapter tube DN 90 with protective cover per system.

Included in all **KRASO® Builder's Convenience boxes - floor!**





KRASO® Builder's Convenience Box - floor **LG 5**

KRASO® Builder's Convenience Box (BKP) - floor, multi utility connection for supply lines (gas, water, electricity, telecommunication) for buildings without basement incl. **KRASO®** FLS 90, incl. installation kits for electricity/water (2 x), telecommunication, electricity + telecommunication as standard configuration for **KRASO®** BKP - floor - 4-fold, desired configuration for the **KRASO®** BKP - floor - 3-fold, 2-fold, 1-fold, **KRASO®** BKP Gas Installation Kits are optionally available | **DafStB** waterproof concrete guideline: stress class 1 + 2, DIN 18533 W1.1 -E

Type / Item	KRASO® BKP - floor			
Height-adjustable to TEUF* in mm from ... to ...	1350 - 1400			
Height-adjustable to TEFF** in mm from ... to ...	12 - 280			
Bending radius in mm	≥ 1000			
Dimensions floor screed insert wiping edge in mm	564 x 90	423 x 90	284 x 90	141 x 90

Type / Item	KRASO® BKP - floor - 4-fold			
incl. KRASO® FLS 90	4 x 3 metres	4 x 6 metres	4 x 9 metres	4 x 12 metres
KRASO® BKP - floor - 4-fold	963 €	1.197 €	1.431 €	1.665 €

Type / Item	KRASO® BKP - floor - 3-fold			
incl. KRASO® FLS 90	3 x 3 metres	3 x 6 metres	3 x 9 metres	3 x 12 metres
KRASO® BKP - floor - 3-fold	834 €	1.010 €	1.185 €	1.361 €

Type / Item	KRASO® BKP - floor - 2-fold			
incl. KRASO® FLS 90	2 x 3 metres	2 x 6 metres	2 x 9 metres	2 x 12 metres
KRASO® BKP - floor - 2-fold	553 €	670 €	787 €	904 €

Type / Item	KRASO® BKP - floor - 1-fold			
incl. KRASO® FLS 90	1 x 3 metres	1 x 6 metres	1 x 9 metres	1 x 12 metres
KRASO® BKP - floor - 1-fold	404 €	463 €	521 €	580 €

Scope of supply; the following details are for the **KRASO®** Builder's Convenience Box - floor - 4-fold with **KRASO®** FLS 90 (3 metres), the delivery is differing with regard to other designs (3-fold, 2-fold, 1-fold).

- foot
- foot extension
- pair of supporting bars
- height-adjustable base plate element 4-fold with gas- and water pressure tight **KRASO®** 4 Seal, trowel flange, visual check for locking-sleeve and pre-installed building period installation cover
- 4 x Flexible Empty Pipe System **KRASO®** FLS 90 (3 metres) with vulcanised locking-sleeve and closure cover
- height-adjustable **KRASO®** BKP Floor Screed Insert with protective cover and lubricant
- height fixation for **KRASO®** BKP Floor Screed Insert (2 pcs.)
- installation instructions **KRASO®** Builder's Convenience Box - floor
- folding rule
- **KRASO®** BKP - floor - extension set including
 - 8 x shrink hose 95/25
 - 4 x adapter tube DN 90 with protective cover
- installation kits including
 - **KRASO®** BKP - Sealing Insert - electricity/water - 2 pcs. with stepless onion ring technology 26 - 50 mm or blind
 - primary sealing + secondary sealing electricity/water
 - casing pipe end plugs including
 - end plugs electricity/water - split -
 - hose connection 90/80

- **KRASO®** BKP - Sealing Insert - telecommunication - clamping range: 5 - 13 mm, 3 x 7 - 13 mm, 13 - 21 mm
 - primary sealing + secondary sealing telecommunication
 - casing pipe end plugs including
 - end plug telecommunication - split -
 - hose connection 90/80
- **KRASO®** BKP - Sealing Insert - electricity + telecommunication - clamping range: electricity 25 - 36 mm / telecommunication 2 x 5 - 10 mm, 3 x 7 - 14 mm
 - primary sealing + secondary sealing electricity + telecommunication
 - casing pipe end plugs including
 - end plug electricity + telecommunication
 - hose connection 80
 - a tube of lubricant

optionally available **KRASO®** BKP Gas Installation Kits:

- **Schuck DN 25** consists of primary and secondary sealing as well as gas end plug
- **RMA DN 25** consists of primary and secondary sealing as well as gas end plug
- **Voigt DN 25** consists of primary and secondary sealing as well as gas end plug
- **Voigt DN 32** consists of primary and secondary sealing as well as gas end plug

* TEUF = Top Edge Unfinished Floor, ** TEFF = Top Edge Finished Floor

**Building
for the future:
one with a
spare
system!**

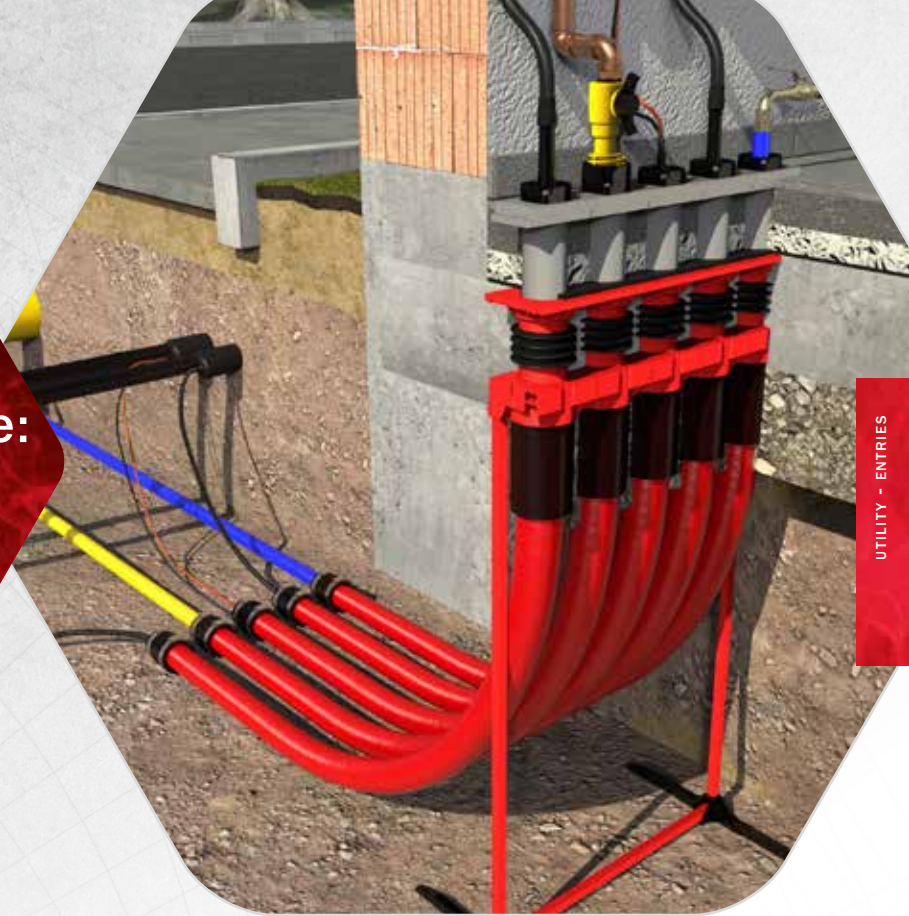

KRASO® Builder's Convenience Box - floor - 5-fold Building for the future: 10 metres empty pipe + 1 system on top

- + Builders build for the future! **Be prepared for future projects and developments** with a fifth system and 10 metres empty pipe system!
- + With an empty pipe system installed to the property boundary, **you can save both costs and time regarding excavation and digging work on your own property in the event of future retrofitting or improving connections.** The **KRASO® Builder's Convenience Box - floor - 5-fold** contains 10 metres of **KRASO® FLS 90** for each section!
- + **DafStB waterproof concrete guideline: stress class 1 + 2, DIN 18533 W1.1 -E**

KRASO® Builder's Convenience Box - floor - 5-fold **LG 5**

KRASO® Builder's Convenience Box (BKP) - floor, multi utility connection for supply lines (gas, water, electricity, telecommunication) for buildings without basement incl. **KRASO® FLS 90**, incl. installation kits for electricity/water (3 x), telecommunication, electricity + telecommunication as standard configuration for **KRASO® BKP - floor - 5-fold**, **KRASO® BKP Gas Installation Kits** are optionally available | **DafStB waterproof concrete guideline: stress class 1 + 2, DIN 18533 W1.1 -E**

Type / Item	KRASO® BKP - floor - 5-fold
Height-adjustable to TEUF* in mm from ... to ...	1350 - 1400
Height-adjustable to TEFF** in mm from ... to ...	12 - 280
Bending radius in mm	≥ 1000
Dimensions floor screed insert wiping edge in mm	705 x 90
incl. KRASO® FLS 90	5 x 10 metres
electricity/water (3 x), telecommunication, electricity + telecommunication	1.627 €

Scope of supply: see **KRASO®** Builder's Convenience Box - floor, but with additional **KRASO® BKP - Sealing Insert - electricity/water -**, 5 x Flexible Empty Pipe System **KRASO® FLS 90** (10 metres)

* TEUF = Top Edge Unfinished Floor, ** TEFF = Top Edge Finished Floor

1 system
on top!



10 metres empty pipe up to the street
= no more dredging!

Single utility connection for buildings without basement

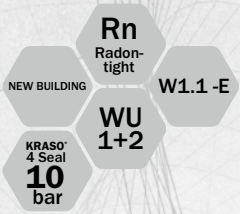

KRASO® Builder's Convenience Box - floor - 110

The flexible utility connection for heat pumps, local, district or geothermal heating, gas, water or electricity

- + The secure utility connection for heat pumps for buildings without basement:
 - KRASO® Builder's Convenience Box - floor - 110 for water-to-water heat-pumps and brine-water-heat pumps (probe and collector)
 - KRASO® Builder's Convenience Box - floor - 110 - SWP for air-to-water heatpump (split).
- + Flexible: also usable for configuring with local, district or geothermal piping systems, gas, water or electricity up to DN 50.
- + With water pressure tight surrounding KRASO® 4 Seal : exterior sealing of concrete: 10 bar!
- + Radon-tight!
- + Hose diameter: external 110 mm - internal 100 mm!
- + Stable installation device with foot extension for a save position and an easy installation
- + For flush-mount installation in the base plate – no tripping hazards, no wall damages! Including building period protection cover
- + Incl. empty pipe insert (25 cm, internal diameter: 100 mm) for a flexible floor construction
- + Incl. Flexible Empty Pipe System KRASO® FLS 110 (internal diameter: 100 mm): bending radius 1000 mm. Incl. hose connection 110 and end plug
- + DafStB waterproof concrete guideline: stress class 1 + 2, DIN 18533 W1.1 -E



KRASO® Builder's Convenience Box - floor - 110

With KRASO® Sealing Insert Universal 100 DD with large flange for internal installation of the lines

Scope of application:

- stepless onion ring technology
18 – 65 mm or blind



KRASO® Builder's Convenience Box - floor - 110 - SWP

With KRASO® Sealing Insert Type SWP with large flange for internal installation of the lines

Scope of application:

- for control cables, closed:
stepless onion ring technology
2 x 5 - 18 mm, with plug
- for refrigerant pipes, split:
 - onion ring technology 1 x 6 - 13 mm
for 1/4 or 3/8 inch pipes, with plug
 - onion ring technology 1 x 6 - 18 mm
for 1/4, 3/8, 1/2 or 5/8 inch pipes,
with plug

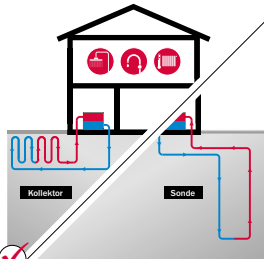
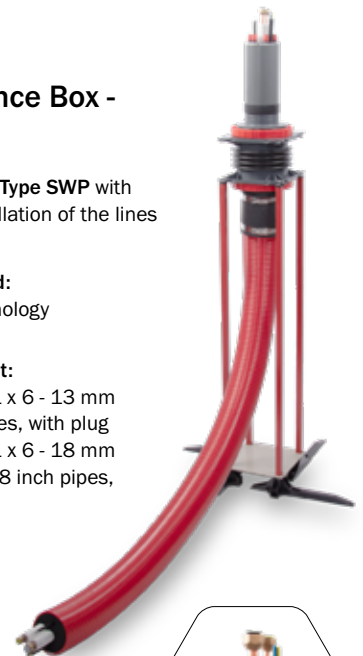

Brine-to-water heat pump
- collector - / - probe -

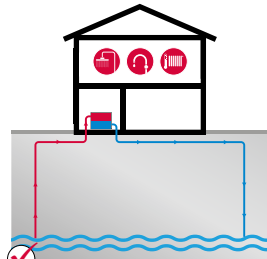

Water-to-water heat pump

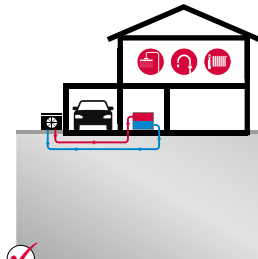

Air-to-water heat pump
- split -



incl. empty pipe insert (25 cm,
internal diameter: 100 mm)



KRASO® Builder's Convenience Box - floor - 110 **IG5**

(including installation set)

KRASO® Builder's Convenience Box (BKP) - floor - 110 – 1-fold, single utility connection for supply lines (heat pump, local/district/geothermal heating, gas, water or electricity) for buildings without basement, incl. KRASO® FLS 110. | DafStB waterproof concrete guideline: stress class 1 + 2, DIN 18533 W1.1 - E

Type / Item	KRASO® BKP - floor - 110 / KRASO® BKP - floor - 110 - SWP			
Height to TEUF in mm	approx. 1185			
Height-adjustable to TEFF in mm to max.	approx. 1435			
Bending radius in mm	1000			
incl. KRASO® FLS 110	3 metres	6 metres	9 metres	12 metres
KRASO® BKP - floor - 110	715 €	814 €	913 €	1.012 €
KRASO® BKP - floor - 110 - SWP	750 €	849 €	948 €	1.047 €

Scope of supply: stable installation device with foot extension, wall penetration for installation flush with the base plate, Flexible Empty Pipe System KRASO® FLS 110 (internal diameter: 100 mm, radius: 1000 mm, incl. hose connection 110, installation set including: empty pipe insert ID 100, approx. 25 cm, KRASO® Sealing Insert Universal 100 DD with large flange, end plug FLS 110 Universal or KRASO® Sealing Insert Type SWP with large flange, end plugs

KRASO®
Builder's Convenience
Box - floor - 110
also available as multi
utility connection





Heat pump technology – simple and tight into the building



- + An efficient heat pump system includes gas- and water pressure tight installation into the building – either through the basement wall or the base plate, with a white or black tank.
- + With or without basement, new building or rehabilitation: **KRASO®** offers various solutions for a simple and tight connection of heat pumps!



KRASO® is a member of **FHRK e.V.**

- + As a member of the Fachverband Hauseinführungen Rohre und Kabel (FHRK e.V.) association, we develop testing principles and technical guidelines together with other manufacturers and users such as utility companies so that the quality of our sealing solutions for utility connections is ensured and can also be compared.



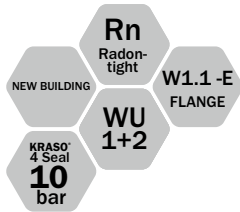

KRASO® Builder's Convenience Box - floor - 150

The safe multi utility connection for larger media lines

- + **The safe utility connection for larger media lines** for buildings without basement, e.g. electricity or water for residential buildings or commercial buildings
- + **Usable with KRASO® Sealing Insert with large flange as utility connection entry or outlet:** e.g. **for charging stations in residential buildings** (flat ownership modernisation law – WEMoG).
- + With water pressure tight surrounding **KRASO® 4 Seal** : **exterior sealing of concrete: 10 bar!**
- + **Radon-tight!**
- + **Stable installation device** incl. rigid empty pipe **with bending radius from 1000 mm**
- + For flush-mount installation in the base plate – no tripping hazards, no wall damages! Including building period protection cover
- + Including empty pipe insert (25 cm, internal diameter: 150 mm) **for a flexible floor construction**
- + Internal installation of media lines via **KRASO® Sealing Inserts**: various designs with stepless onion ring technology
- + External optional connection possibilities: connection to **KRASO® FLS**, cable protective hoses DN 110 or DN 160 or KG empty pipe systems with DN 160
- + Optionally available: **KRASO® Trowel Flange**
- + **DafStB waterproof concrete guideline: stress class 1 + 2, DIN 18533 W1.1 -E**

KRASO® Builder's Convenience Box - floor - 150 **LG 5**

single utility connection for supply lines, for buildings without basement, with water pressure tight surrounding **KRASO® 4 Seal** | **DafStB waterproof concrete guideline: stress class 1 + 2, DIN 18533 W1.1 -E**

Type / Item	KRASO® BKP - floor - 150			
Height to TEUF in mm	approx. 1220			
Height-adjustable to TEFF in mm to max.	approx. 1470			
Bending radius in mm	1000			
KRASO® Sealing Insert with large flange	Design 1	Design 2	Design 3	Design 4
Stepless onion ring technology: external cable diameter from... to ... in mm	3 x 6 - 52 mm or Blind	4 x 6 - 18 mm and 6 x 6 - 33 mm or Blind	6 x 6 - 38 mm or Blind	1 x 50 - 92 mm or Blind
KRASO® System Cover – either:	Design 1	Design	Design 3	
	hose connection 160	hose connection 110	plug-in sleeve DN 160	
KRASO® BKP - floor - 150	821 €			
optional: KRASO® Trowel Flange	93 €			

Scope of supply: rigid empty pipe 150 incl. stable installation device, empty pipe insert ID150, approx. 25cm, **KRASO® Sealing Insert with large flange** for the installation in **KRASO® Empty Pipe Insert**, **KRASO® System Cover** for the connection of on-site empty pipe

Simple, comfortable, tight to the heat pump or to the local, district and geothermal energy network



KRASO® Builder's Convenience Box - floor - NFE - Basis

Simple, comfortable, tight up to the heat pump or to the local, district and geothermal energy network

- + The comfortable solution for the connection to air-water-heat pump (monobloc) or to the local, district and geothermal energy network – for flexible and insulated pipelines with integrated supply and reflux
- + Fully assembled stable installation device:
positioning – arrangement – concreting – connection – ready!
- + **For buildings without basement:**
single-/multi-family houses, public and commercial buildings
- + On request also available with **KRASO® Foil Flange** – for the integration into the floor sealing
- + **KRASO® Builder's Convenience Box - floor - NFE - Basis** including:
 - **KRASO® Builder's Convenience Box - floor - NFE - Basis DN 200, DN 250 or DN 315** with water pressure tight surrounding **KRASO® 4 Seal**
 - **KRASO® Empty Pipe Insert KG 2000:** for the internal floor construction
 - Building period protection cover
- + **DafStB waterproof concrete guideline: stress class 1 + 2, DIN 18533 W1.1 - E**



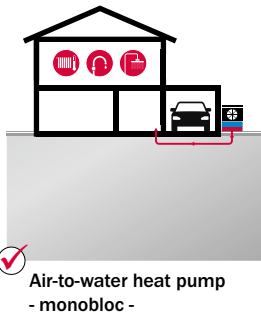
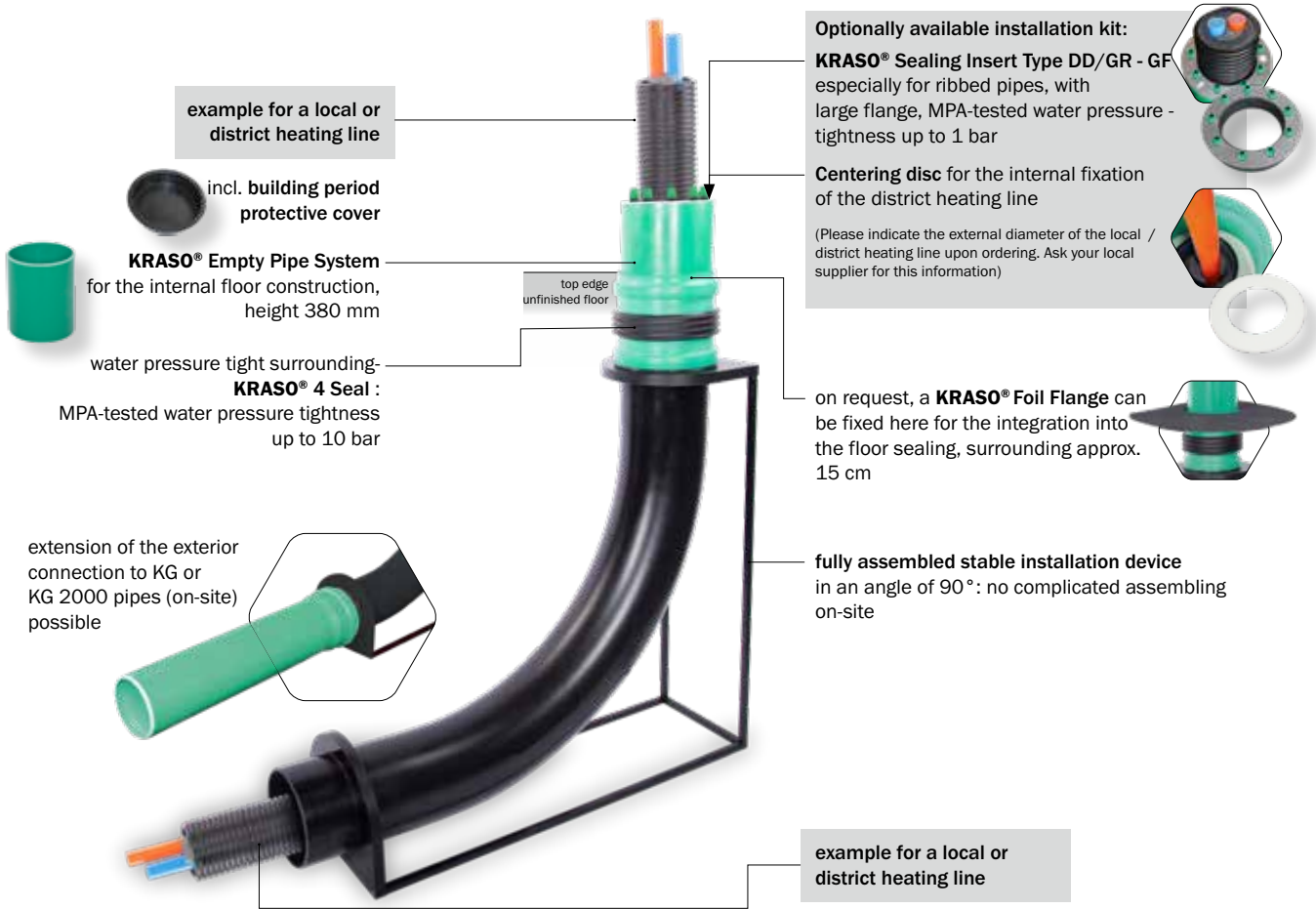

KRASO® Builder's Convenience Box - floor - NFE - Basis available as 2-fold system!



KRASO® Builder's Convenience Box - floor - NFE - Basis **LG 5**

for the connection to the local, district and geothermal energy network. Optionally available: **KRASO®** Foil Flange for the integration into the floor sealing | DafStB waterproof concrete guideline: stress class 1 + 2, DIN 18533 W1.1 -E

Type / Item	KRASO® BKP - floor - NFE - Basis				
Diameter DN	DN 200	DN 200	DN 200	DN 250	DN 315
Bending radius in mm	800	1000	1250	800	1000
KRASO® BKP - floor - NFE - Basis	905 €	955 €	1.017 €	981 €	1.143 €
KRASO® Foil Flange (optionally available)	235 €	235 €	235 €	306 €	395 €
Installation kit (optionally available)	280 €	280 €	280 €	336 €	429 €

Scope of supply: KRASO® Builder's Convenience Box - floor - NFE - Basis with installation device, empty pipe insert and building period protective cover - optionally available: **KRASO®** Foil Flange, installation kit with **KRASO®** Sealing Insert Type DD/GR - GF and centering disc

Two-fold version on request!



KRASO® BKP - floor - 1-fold



KRASO® BKP - floor - 2-fold



KRASO® BKP - floor - 3-fold



KRASO® BKP - floor - NFE - Basis - 2-fold

	KRASO® Builder's Convenience Box				
	- floor	- floor - 110 -	- floor - 110 - SWP	- floor - 150 -	- floor - NFE - Basis
Single utility connection	✓	✓	✓	✓	✓
Multi utility connection	✓	✓	-	✓	✓
Gas	✓	✓	-	-	-
Water	✓	✓	-	✓	-
Electricity	✓	✓	-	✓	-
Telecommunication	✓	✓	-	✓	-
Local/geothermal/district heating	-	✓	-	-	✓
Heat pump	-	✓	✓	-	✓
DVGW approved in accordance with VP 601: whole system is gas and water pressure-tight up to 1 bar!	✓	-	-	-	-
KRASO® 4 Seal : exterior sealing of concrete: 10 bar!	✓	✓	✓	✓	✓
Gas- and odour-tight – high-quality in terms of TA-Air!	✓	✓	✓	✓	-
Radon tightness IAF tested		Rn Radon-tight	Rn Radon-tight	Rn Radon-tight	Rn Radon-tight
DafStB waterproof concrete guideline / DIN 18533	WU 1+2 W1.1 -E	WU 1+2 W1.1 -E	WU 1+2 W1.1 -E	WU 1+2 W1.1 -E	WU 1+2 W1.1 -E
External/internal diameter KRASO® FLS in mm or nominal size of arc (- floor - NFE)	90/80	110/100	110/100	Connection via KRASO® System Cover	DN 200 DN 250 DN 315
Bending radius in mm	≥ 1000	≥ 1000	≥ 1000	1000	800 (DN 200) 800 (DN 250) 1000 (DN 315)
Height to TEUF in mm	1350 - 1400 (adjustable)	approx. 1185	approx. 1185	1265	1300 (DN 200) 1365 (DN 250) 1490 (DN 315)
Height-adjustable to TEFF in mm from ... to ... or height to OKFF in mm	12 - 280 (adjustable)	approx. 1435	approx. 1435	1515	0 - 250 (adjustable on-site)
Installation kit	✓	✓	✓	✓	optional
Scope of application KRASO® BKP - Sealing Insert - electricity/water	26 - 50 mm or blind	-	-	KRASO® Sealing insert with large flange: Design 1: 3 x 6 - 52 mm or Blind Design 2: 4 x 6 - 18 mm and 6 x 6 - 33 mm or Blind Design 3: 6 x 6 - 38 mm or Blind Design 4: 1 x 50 - 92 mm or Blind	-
Scope of application KRASO® BKP - Sealing Insert - telecommunication	5 - 13 mm 3 x 7 - 13 mm 13 - 21 mm	-	-		-
Scope of application KRASO® BKP - Sealing Insert - electricity + telecommunication	electricity 25 - 36 mm telecommunication 2 x 5 - 10 mm 3 x 7 - 14 mm	-	-		-
Scope of application KRASO® Sealing Insert Universal 100 DD with large flange	-	18 - 65 mm or blind	-		-
Scope of application KRASO® Sealing Insert Type SWP with large flange	-	-	For control cables, closed: stepless onion ring technology 2 x 5 - 18 mm, with plug For refrigerant lines, split: • onion ring technology 1 x 6 - 13 mm for 1/4 or 3/8 inch pipes, with plug • onion ring technology 1 x 6 - 18 mm for 1/4, 3/8, 1/2 or 5/8 inch pipes, with plug	-	
Scope of application KRASO® Sealing Insert Type DD/GR with large flange*	-	-	-	-	0 - 155 mm (DN 200) 0 - 201 mm (DN 250) 0 - 262 mm (DN 315)
Optionally available KRASO® BKP gas installation kits	• Schuck DN 25 • RMA DN 25 • Voigt DN 25 • Voigt DN 32	-	-	-	-

* Scope of application sealing insert - when choosing the utility connection, take the bending radius of the media line into account. Material and rigidity vary between different manufacturers.



KRASO® Builder's Convenience Box - wall
Check the installation video
(just scan the QR code!)

**Multi utility
connection for
buildings with
basement**



KRASO® Builder's Convenience Box - wall Multi utility connection for buildings with basement: gas, water, electricity and telecommunication

- + **DVGW-certified according to VP 601:** complete system is gas- and water pressure tight up to 1 bar!
- + For core drilling and casing DN 200 (199 - 203 mm). **For precast walls and in-situ concrete walls!**
- + External sealing element with **flange according to DIN 18533!** Seal: 80 mm
- + **Tight in waterproof concrete structures with stress class 1** (permanently or temporarily pressing water).
- + **Radon tightness IAF tested** - meets the requirements for radon precautionary areas according to FHRK leaflet MB 101! **Resistant to methane gas!**
- + Torque Control Nut **KRASO® DKM:** integrated torque limiter - **no torque wrench required!**
- + Split end plugs for **easy installation!**
- + Ready for the network connection of gas, water, electricity and telecommunication:
Tested in accordance with DVGW! Including **KRASO® BKP - Sealing Inserts for electricity/water, telecommunication, electricity + telecommunication**
- + **Optionally available KRASO® BKP Gas Installation Kits:**
 - gas utility connection Schuck DN 25
 - gas utility connection RMA DN 25
 - gas utility connection Voigt DN 25
 - gas utility connection Voigt DN 32
- + Including **KRASO® BKP - wall - extension set!**
- + DafStB waterproof concrete guideline: stress class 1 + 2, DIN 18533 W1 -E and W2.1 -E

KRASO® BKP - wall - extension set including
- 4 x double sleeve DN 75
- 8 x sealing ring
- lubricant



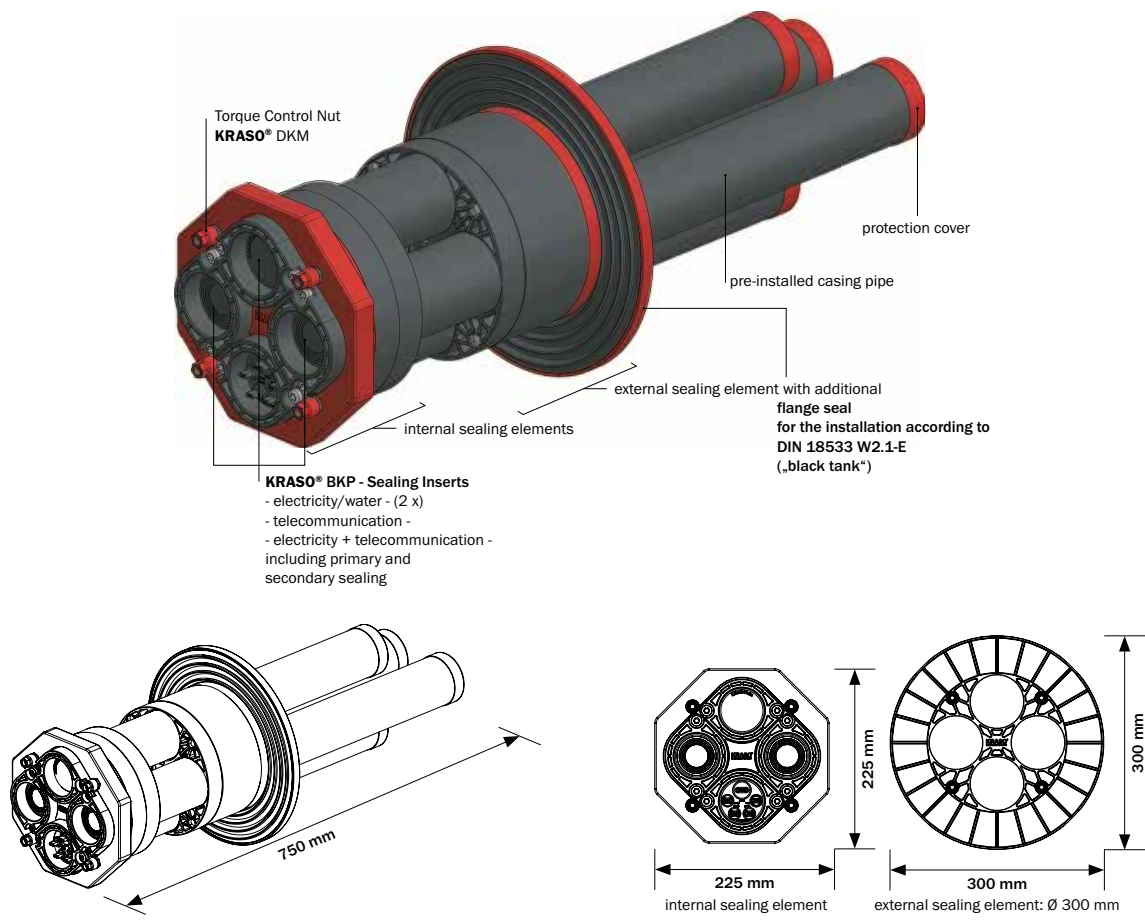

KRASO® Builder's Convenience Box - wall **LG5**

multi utility connection for supply lines (gas, water, electricity, telecommunication) for buildings with basement, **KRASO® BKP Gas Installation Kits** optionally available | **DafStB waterproof concrete guideline: stress class 1 + 2, DIN 18533 W1 -E and W2.1 -E**

Type / Item	KRASO® BKP - wall
Wall thickness from ... to ...	200 - 500 mm
Diameter core drilling min ... max ...	199 - 203 mm
Length complete system	750 mm
Length x width internal sealing element	225 x 225 mm
Diameter external sealing element	300 mm
Internal diameter casing pipes	68 mm
External diameter casing pipes	75 mm
KRASO® BKP - wall	772 €

Scope of supply:

- **KRASO® Builder's Convenience Box - wall** including
 - internal sealing element with pre-installed casing pipes incl. protective cover for the installation of supply lines such as gas, water, electricity, telecommunication
 - external sealing element
- **KRASO® BKP - wall - extension set** including
 - 4 x double sleeve DN 75
 - 8 x sealing ring
 - lubricant
- installation instructions **KRASO® Builder's Convenience Box - wall**
- folding rule
- installation kits including
 - **KRASO® BKP - Sealing Insert - electricity/water** - 2 pcs. with stepless onion ring technology 26 - 50 mm or blind
 - primary sealing + secondary sealing electricity/water
 - casing pipe end plugs including
 - end plug electricity/water - split -
 - hose connection 80
 - **KRASO® BKP - Sealing Insert - telecommunication** - clamping range: 5 - 13 mm, 3 x 7 - 13 mm, 13 - 21 mm
 - primary sealing + secondary sealing telecommunication
 - casing pipe end plugs including
 - end plug telecommunication - split -
 - hose connection 80

- **KRASO® BKP - Sealing Insert - electricity + telecommunication** - clamping range: electricity 25 - 36 mm / telecommunication 2 x 5 - 10 mm, 3 x 7 - 14 mm
 - primary sealing + secondary sealing electricity + telecommunication
 - casing pipe end plugs including
 - end plug electricity + telecommunication
 - hose connection 80
 - a tube of lubricant

optionally available **KRASO® BKP Gas Installation Kits:**

- **Schuck DN 25** consists of primary and secondary sealing as well as gas end plug
- **RMA DN 25** consists of primary and secondary sealing as well as gas end plug
- **Voigt DN 25** consists of primary and secondary sealing as well as gas end plug
- **Voigt DN 32** consists of primary and secondary sealing as well as gas end plug

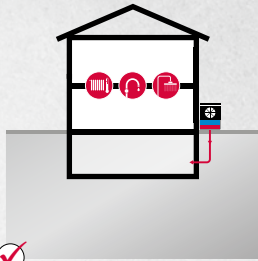

✓ Air-to-water heat pump
- monobloc -

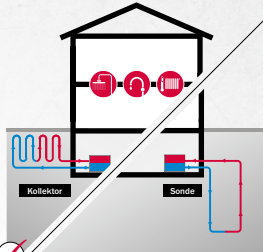

✓ Brine-to-water heat pump
- collector - / - probe -

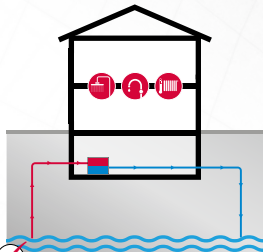

✓ Water-to-water heat pump

Multi utility
connection for
buildings with
basement



KRASO® Builder's Convenience Box - wall - NFE

Comfortable connection to your basement: heat pump, local, district or geothermal heating

- + Heat pumps- or local, district or geothermal heating system each with supply and reflux!
- + For heat pumps or local, district or geothermal heating lines with diameter 110, 90, 75, 50, 40 or 32 mm, optionally available with a diameter of 125 mm.
- + For core drilling and casing DN 300 (299 - 303 mm). For precast walls and in-situ concrete walls!
- + External sealing element with flange according to DIN 18533!
Seal: 90 mm.
- + Gas- and odour-tight - high-quality in terms of TA-Air!
- + Certified up to 1 bar!
- + Radon tightness IAF tested - according to FHRK leaflet MB 101! Resistant to methane gas!
- + Torque Control Nut KRASO® DKM: integrated torque limiter - no torque wrench required!
- + Including all components for a secure grid connection of heat pump, local, district or geothermal heating, water, electricity and telecommunication!
- + Including casing pipe end plugs – cold bridges are avoided!
- + Optionally available: KRASO® BKP - wall - NFE - extension set – for cable protective hoses, KRASO® FLS or rigid casing pipes!
- + DafStB waterproof concrete guideline: stress class 1 + 2, DIN 18533 W1 -E and W2.1 -E

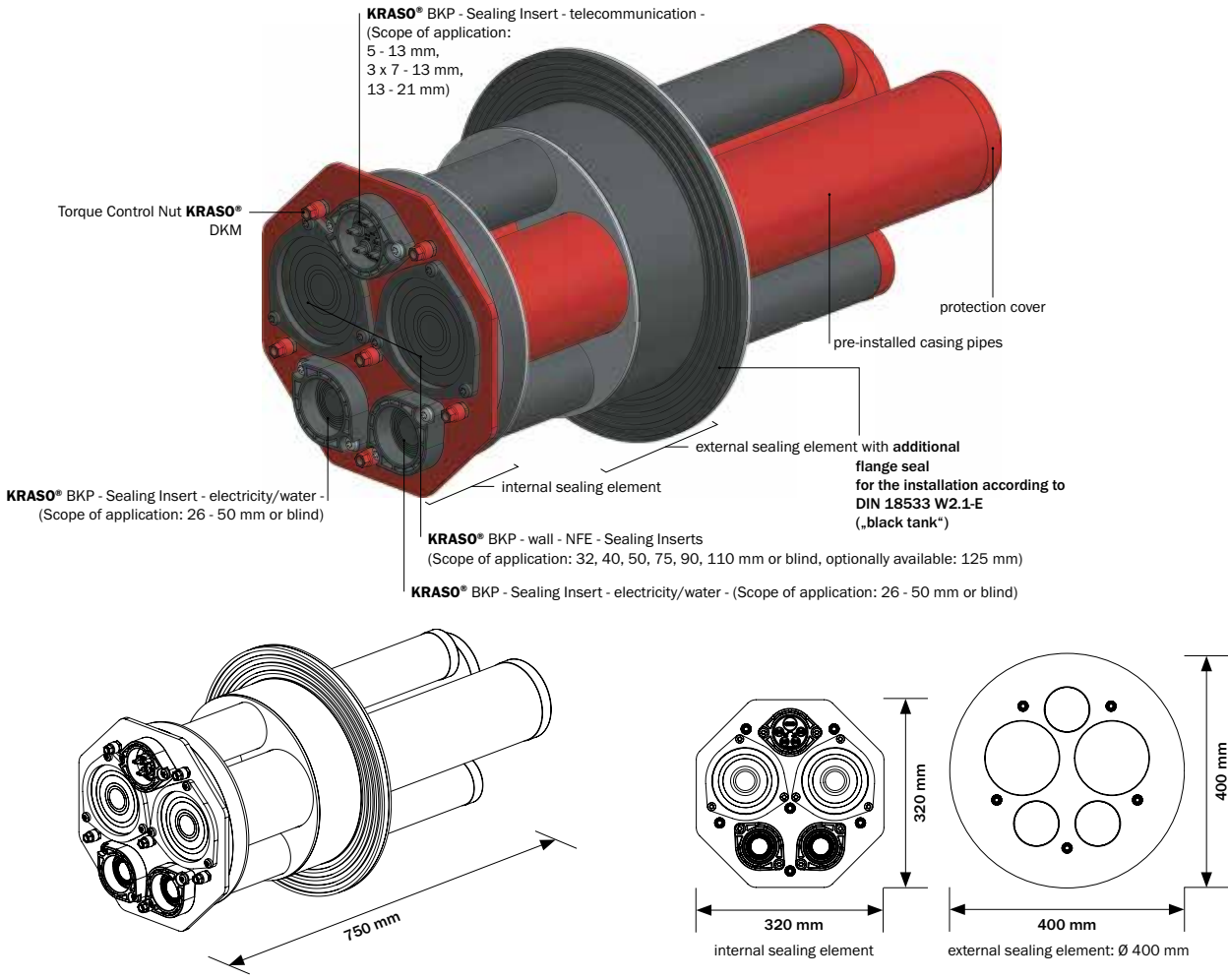

KRASO® Builder's Convenience Box - wall - NFE **LG5**

multi utility connection for supply lines (local, district or geothermal heating, water, electricity, telecommunication) for buildings with basement | DafStB waterproof concrete guideline: stress class 1 + 2, DIN 18533 W1 -E and W2.1 -E

Type / Item	KRASO® BKP - wall - NFE
Wall thickness from ... to ...	200 - 500 mm
Diameter core drilling min ... max ...	299 - 303 mm
Length complete system	750 mm
Length x width internal sealing element	320 x 320 mm
Diameter external sealing element	400 mm
Seal width external sealing element	90 mm
Internal diameter casing pipes	68 mm
External diameter casing pipes	75 mm
Internal diameter casing pipes NFE	118 mm
External diameter casing pipes NFE	125 mm
KRASO® BKP - wall - NFE	1,225 €

Scope of supply; KRASO® Builder's Convenience Box - NFE including

- internal sealing element with 5 casing pipes for the installation of supply lines for heat pump, local, district or geothermal heating (supply and reflux), water, electricity and telecommunication incl. protection covers
- external sealing element
- installation instructions
- KRASO® Builder's Convenience Box - wall - NFE**
- folding rule
- installation kit including
 - **KRASO® BKP - wall - NFE - Sealing Insert** – 2 pcs.
Scope of application: 32, 40, 50, 75, 90, 110 mm or blind, optionally available: 125 mm
 - primary sealing + secondary sealing NFE
 - 2 x end plug NFE
 - 2 x hose connection 125/125

- **KRASO® BKP - Sealing Insert - electricity/water** - 2 pcs. with stepless onion ring technology 26 - 50 mm or blind
- primary sealing + secondary sealing electricity/water
- casing pipe end plugs including:
 - end plug electricity/water - split -
 - hose connection 80
- **KRASO® BKP - Sealing Insert - telecommunication** - clamping range: 5 - 13 mm, 3 x 7 - 13 mm, 13 - 21 mm
- primary sealing + secondary sealing telecommunication
- casing pipe end plugs including:
 - end plug telecommunication - split -
 - hose connection 80

Optionally available:

- **KRASO® BKP - wall - NFE - extension set**

Further wall thicknesses available on request!



KRASO® Builder's Convenience Box - wall - ESH
Check the installation video
(just scan the QR code!)

**Single utility
connection for
buildings with
basement**



UTILITY - ENTRIES

KRASO® Builder's Convenience Box - wall - ESH Convenient, safe, tight connection to the network – gas, water, electricity or telecommunication

- + Simple and safe **single utility connection for new buildings or rehabilitation** for buildings with basement
- + **Flexible installation:** gas, water, electricity or telecommunication – including installation / mounting set
- + **Double installation possible: electricity and telecommunication!**
- + **DVGW-certified according to VP 601: complete system is gas- and water pressure tight up to 1 bar!**
- + For core drilling and casing DN 100 (99 - 103 mm). **For precast walls and in-situ concrete walls!**
- + For wall thickness from **160 – 500 mm**
- + **Tight in waterproof concrete structures with stress class 1** (permanently or temporarily pressing water)
- + **External sealing element with flange according to DIN 18533!** Seal: 80 mm
- + **Radon tightness IAF tested** - according to FHRK leaflet MB 101! **Resistant to methane gas!**
- + **Gas- and odour-tight – high-quality in terms of TA-Air!**
- + **Split end plugs for easy installation!**
- + **Including extension set**
- + **DafStB waterproof concrete guideline: stress class 1 + 2, DIN 18533 W1 -E and W2.1 -E**

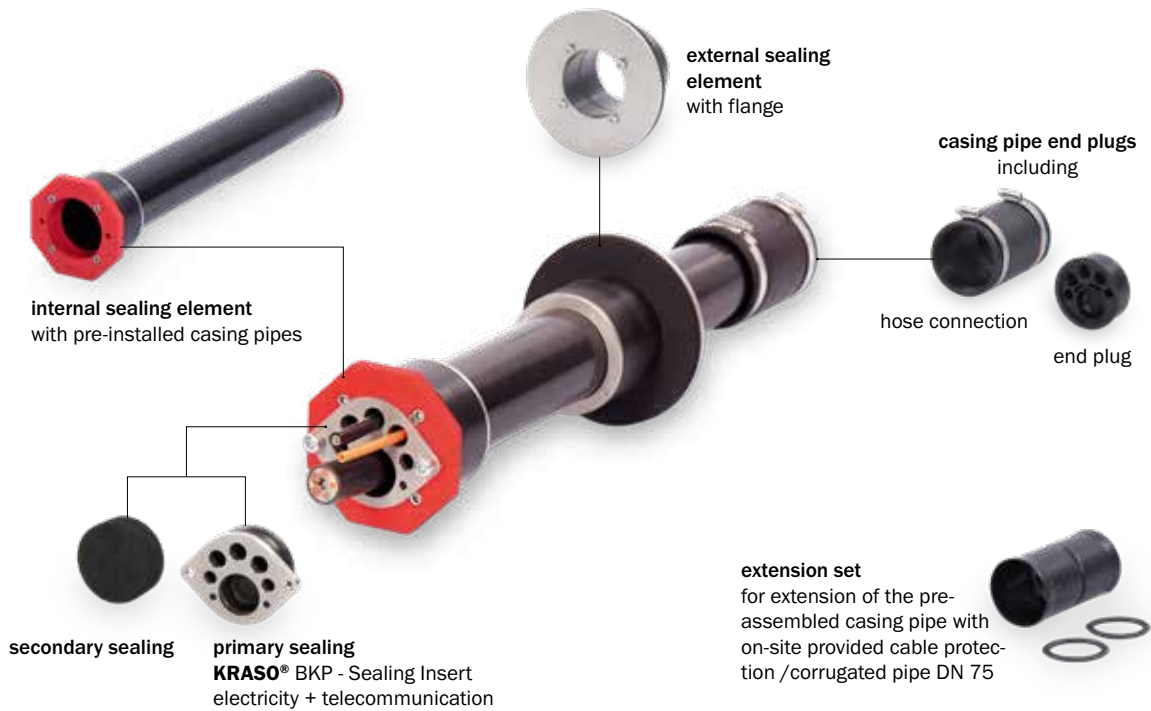

KRASO® Builder's Convenience Box - wall - ESH **LG 5**

(including installation set)

single utility connection for supply lines (gas, water, electricity or telecommunication) for buildings with basement, incl. extension set | **DafStB**
 waterproof concrete guideline: stress class 1 + 2, DIN 18533 W1 -E and W2.1 -E

Type / Item	KRASO® BKP - wall - ESH
Wall thickness from ... to ...	160 - 500 mm
Diameter casing or core drilling min ... max ...	99 - 103 mm
Length complete system	630 mm
Length x width internal sealing element	120 x 120 mm
Seal width internal sealing element	40 mm
Diameter external sealing element with flange seal	160 mm
Seal external sealing element with flange seal	80 mm
Internal diameter casing pipe	68 mm
External diameter casing pipe	75 mm
KRASO® BKP - wall - ESH	277 €

Scope of supply: KRASO® Builder's Convenience Box - wall - ESH including

- internal sealing element with pre-installed casing pipe incl. protective cover for the installation of supply lines such as gas, water, electricity or telecommunication
 - external sealing element
 - installation instructions **KRASO® BKP - wall - ESH**
 - folding rule
- **KRASO® BKP - wall - ESH - extension set** including
 - double sleeve DN 75
 - 2 x sealing ring
 - lubricant
- **KRASO® BKP - Sealing Insert - electricity + telecommunication** - clamping range: electricity 25 - 36 mm / telecommunication 2 x 5 - 10 mm, 3 x 7 - 14 mm
 - primary sealing + secondary sealing electricity + telecommunication
 - casing pipe end plugs including:
 - end plug electricity + telecommunication
 - hose connection 80
 - a tube of lubricant

as well as one of the following, optionally available installation kits or BKP gas installation kits:

- **KRASO® BKP - Sealing Insert - electricity/water** with stepless onion ring technology 26 - 50 mm or blind
 - primary sealing + secondary sealing electricity/water
 - casing pipe end plugs including
 - end plug electricity/water - split -
 - hose connection 80
- **KRASO® BKP - Sealing Insert - telecommunication** - clamping range: 5 - 13 mm, 3 x 7 - 13 mm, 13 - 21 mm
 - primary sealing + secondary sealing telecommunication
 - casing pipe end plugs including
 - end plug telecommunication - split -
 - hose connection 80

- **Schuck DN 25** consists of primary and secondary sealing as well as gas end plug
- **RMA DN 25** consists of primary and secondary sealing as well as gas end plug
- **Voigt DN 25** consists of primary and secondary sealing as well as gas end plug
- **Voigt DN 32** consists of primary and secondary sealing as well as gas end plug

Further wall thicknesses available on request!

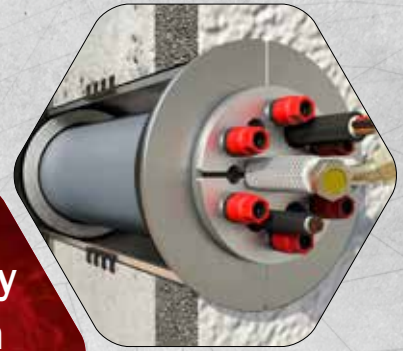

Single utility connection for heat pumps

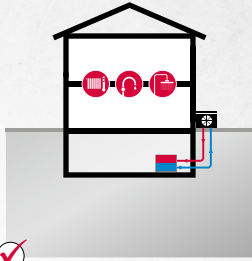

✓ Air-to-water heat pump - Split -



KRASO® Builder's Convenience Box - wall - SWP

Utility connection system for air-water heat pumps (split)

- + Simple and safe single-utility connection for new buildings and rehabilitation of buildings with a basement
 - + For core drilling and casing DN 150 (149 - 153 mm). For precast walls, in-situ concrete walls and brickwork, for wall thicknesses from 160 – 500 mm
 - + External sealing element with flange according to DIN 18533! Seal: 80 mm
 - + With KRASO® Sealing Insert Type SWP with large flange for internal installation.
- Scope of application:**
- For control cables, closed:
 - stepless onion ring technology
 - 2 x 5 - 18 mm, with plug
 - For refrigerant lines, split:
 - ring technology 1 x 6 - 13 mm for 1/4 or 3/8 inch pipes, with plug
 - ring technology 1 x 6 - 18 mm for 1/4, 3/8, 1/2 or 5/8 inch pipes, with plug
- + Radon tightness IAF tested - according to FHRK leaflet MB 101!
 - + DafStB waterproof concrete guideline: stress class 1 + 2, DIN 18533 W1 -E and W2.1 -E

KRASO® Builder's Convenience Box - wall - SWP **LG 5**

single utility connection for control cables and refrigerant lines of air-water heat pumps (split) for buildings with basement | DafStB waterproof concrete guideline: stress class 1 + 2, DIN 18533 W1 -E and W2.1 -E

Type / Item	KRASO® BKP - wall - SWP
Wall thickness from ... to ...	160 - 500 mm
Diameter casing or core drilling min ... max ...	149 - 153 mm
Length complete system	630 mm
Seal width internal sealing element	30 mm
Diameter external sealing element	250 mm
Seal width external sealing element	80 mm
Internal diameter casing pipe	100 mm
External diameter casing pipe	110 mm
KRASO® BKP - wall - SWP	353 €



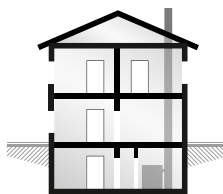

Scope of supply: KRASO® Builder's Convenience Box - wall - SWP incl. KRASO® Sealing Insert Type SWP with large flange
Further wall thicknesses available on request!



Buildings with basement



KRASO® Builder's Convenience Box





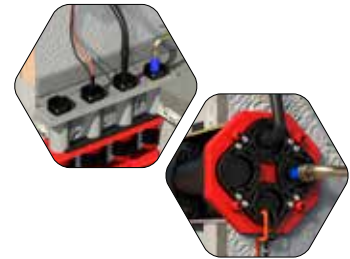









	- wall -	- wall - ESH	- wall - SWP	- wall - NFE																
Single utility connection system	-	✓	✓	-																
Multi utility connection system	✓	-	-	✓																
Gas	✓	✓	-	-																
Water	✓	✓	-	✓																
Electricity	✓	✓	-	✓																
Telecommunication	✓	✓	-	✓																
Local/geothermal/district heating	-	-	-	✓																
Heat pump	-	-	✓	✓																
DVGW-certified according to VP 601: complete system is gas- and water pressure tight up to 1 bar!	✓	✓	-	-																
External sealing element with flange according to DIN 18533! seal: 80 mm	✓	✓	✓	✓																
Gas- and odour-tight – high-quality in terms of TA-Air!	✓	✓	✓	-																
Radon tightness IAF tested																				
DafStB waterproof concrete guideline / DIN 18533	<table border="1"><tr><td>WU</td><td>W1-E</td></tr><tr><td>1+2</td><td>W2.1-E</td></tr></table>	WU	W1-E	1+2	W2.1-E	<table border="1"><tr><td>WU</td><td>W1-E</td></tr><tr><td>1+2</td><td>W2.1-E</td></tr></table>	WU	W1-E	1+2	W2.1-E	<table border="1"><tr><td>WU</td><td>W1-E</td></tr><tr><td>1+2</td><td>W2.1-E</td></tr></table>	WU	W1-E	1+2	W2.1-E	<table border="1"><tr><td>WU</td><td>W1-E</td></tr><tr><td>1+2</td><td>W2.1-E</td></tr></table>	WU	W1-E	1+2	W2.1-E
WU	W1-E																			
1+2	W2.1-E																			
WU	W1-E																			
1+2	W2.1-E																			
WU	W1-E																			
1+2	W2.1-E																			
WU	W1-E																			
1+2	W2.1-E																			
Diameter casing or core drilling	DN 200 (199 - 203 mm)	DN 100 (99 - 103 mm)	DN 150 (149 - 153 mm)	DN 300 (299 - 303 mm)																
Wall thickness* in mm from ... to ...	200 - 500	160 - 500	160 - 500	200 - 500																
Length complete system in mm	750	630	630	750																
External/internal diameter casing pipe(e) in mm	75/68	75/68	110/100	75/68 110/103,6 (NFE)																
Length x width/diameter of internal sealing element in mm	225 x 225	120 x 120	170	320 x 320																
Diameter/seal width of external sealing element in mm	300/80	160/80	250/80	400/90																
Installation kit	✓	✓	✓	✓																
Scope of application KRASO® BKP - Sealing Insert - electricity/water	26 - 50 mm or blind	26 - 50 mm or blind	-	26 - 50 mm or blind																
Scope of application KRASO® BKP - Sealing Insert - telecommunication	5 - 13 mm 3 x 7 - 13 mm 13 - 21 mm	5 - 13 mm 3 x 7 - 13 mm 13 - 21 mm	-	5 - 13 mm 3 x 7 - 13 mm 13 - 21 mm																
Scope of application KRASO® BKP - Sealing Insert - electricity + telecommunication	electricity 25 - 36 mm telecommunication 2 x 5 - 10 mm 3 x 7 - 14 mm	electricity 25 - 36 mm telecommunication 2 x 5 - 10 mm 3 x 7 - 14 mm	-	electricity 25 - 36 mm telecommunication 2 x 5 - 10 mm 3 x 7 - 14 mm																
Scope of application KRASO® BKP - wall - Sealing Insert - NFE	-	-	-	32, 40, 50, 75, 90, 110 mm or blind, optionally available: 125 mm																
Scope of application KRASO® Sealing Insert Type SWP with large flange	-	-	for control cables, closed: stepless onion ring technology 2 x 5 - 18 mm, with plug for refrigerant lines, split: • onion ring technology 1 x 6 - 13 mm for 1/4 or 3/8 inch pipes, with plug • onion ring technology 1 x 6 - 18 mm for 1/4, 3/8, 1/2 or 5/8 inch pipes, with plug	-																
optionally available KRASO® BKP gas installation kits -	• Schuck DN 25 • RMA DN 25 • Voigt DN 25 • Voigt DN 32	• Schuck DN 25 • RMA DN 25 • Voigt DN 25 • Voigt DN 32	-	-																

* Further wall thicknesses available on request



KRASO® BKP - Sealing Inserts **LG 5**

Installation kits for **KRASO®** Builder's Convenience Box - floor and **KRASO®** Builder's Convenience Box - wall, wall - NFE and wall - ESH: electricity/water, telecommunication, electricity + telecommunication. Tested in accordance with DVGW!

Sealing insert including		Casing pipe end plugs (optional) including		
Primary sealing	Secondary sealing	End plug	Hose connection	
 <p>Primary sealing electricity/water for internal installation of electricity cable or water pipeline clamping range: 26 - 50 mm</p>	 <p>Secondary sealing electricity/water for internal installation of electricity cable or water pipeline</p>	 <p>End plug electricity/water - split - for external installation of electricity cable or water pipeline</p>	 <p>Hose connection 90/80 for KRASO® BKP - floor - 90 for the connection with the casing pipe and fitting of the end plugs for electricity/water - split -</p>	 <p>Hose connection 80 for KRASO® BKP - wall for the connection with the casing pipe and fitting of the end plugs for electricity/water - split -</p>
 <p>Primary sealing telecommunication for internal installation of the telecommunication lines clamping range: 5 - 13 mm 3 x 7 - 13 mm 13 - 21 mm</p>	 <p>Secondary sealing telecommunication for internal installation of the telecommunication lines</p>	 <p>End plug telecommunication - split - for external installation of the telecommunications lines</p>	 <p>Hose connection 90/80 for KRASO® BKP - floor - 90 for the connection with the casing pipe and fitting of the end plugs for telecommunication - split -</p>	 <p>Hose connection 80 for KRASO® BKP - wall for the connection with the casing pipe and fitting of the end plugs for telecommunication - split -</p>
 <p>Primary sealing electricity + telecommunication for internal installation of the electricity- and telecommunication lines clamping range: electricity 25 - 36 mm telecomm. 2 x 5 - 10 mm 3 x 7 - 14 mm</p>	 <p>Secondary sealing electricity + telecommunication for internal installation of the electricity- and telecommunication lines</p>	 <p>End plug electricity + telecommunication for external installation of the electricity- and telecommunication lines</p>	 <p>Hose connection 90/80 for KRASO® BKP - floor - 90 for the connection with the casing pipe and fitting of the end plugs for telecommunication - split -</p>	 <p>Hose connection 80 for KRASO® BKP - wall for the connection with the casing pipe and fitting of the end plugs for telecommunication - split -</p>

Type / Item	- Electricity/water -	- Telecommunication -	- Electricity + telecommunication -
KRASO® BKP - Sealing Insert			54 €
Casing pipe end plugs (optional)			32 €

Scope of supply: as an installation kit for electricity/water, telecommunication or electricity + telecommunication, **KRASO® BKP - Sealing Insert**, including primary sealing and secondary sealing, optionally available casing pipe end plugs including end plug and hose connection 90/80 (floor) or hose connection 80 (wall)



KRASO® BKP Floor Screed Insert 1-fold



KRASO® BKP Floor Screed Insert **LG 5**

for **KRASO®** Builder's Convenience Box - floor - 1- to 4-fold, with height fixation, protection foil and lubricant, adjustable height from 12 to 280 mm or 12 to 590 mm

Type / Item	1-fold	2-fold	3-fold	4-fold
KRASO® BKP Floor Screed Insert (12 - 280 mm)	55 €	109 €	163 €	217 €
KRASO® BKP Floor Screed Insert (12 - 590 mm)	83 €	165 €	248 €	330 €

Scope of supply: **KRASO® BKP Floor Screed Insert** with height fixation, protection foil and lubricant

Further heights on request!



KRASO® BKP Gas Installation Kits **LG 5**

for anti-twist and tear-off protection of gas utility connections, according to DVGW VP 601, incl. primary and secondary elements, gas end plug and self-cutting screws



Type / Item	KRASO® BKP Gas Installation Kits			
Gas utility connection	Schuck DN 25	RMA DN 25*	Voigt DN 25	Voigt DN 32
KRASO® BKP Gas Installation Kit	64 €	64 €	64 €	171 €

* for rigid and flexible designs

Scope of supply: KRASO® BKP Gas Installation Kit



KRASO® BKP - wall - NFE - extension set **LG 5**

for the extension of the casing pipes for water, electricity and telecommunication in the KRASO® Builder's Convenience Box - wall - NFE with a cable protection hose provided on-site



Type / Item	KRASO® BKP - wall - NFE - extension set
KRASO® BKP - wall - NFE - extension set	104 €

Scope of supply: KRASO® BKP - wall - NFE - extension set including 6 x shrink hose 95/25, 3 x adapter hose DN 75

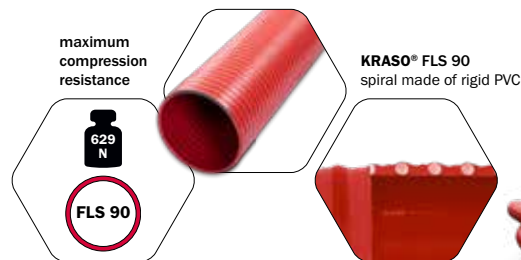

KRASO® FLS 90 - Flexible Empty Pipe System **LG 4**

flexible empty pipe system as a cable protective hose for the extension of the KRASO® Builder's Convenience Box - floor - 90 using the KRASO® extension set, with a smooth interior for easy cable pulling, smooth exterior for optimal sealing, flexible, high axial resistance, resistant to alkalis and acids, resistant to brine and sea water, good UV and ozone resistance, gas-tight and liquid-tight, RoHS-compliant (Restriction of Hazardous Substances), compression resistance 629 N, tests in line with DIN EN 61386-24 lead to the following classifications: Type 250 - Impact resistance: Normal - Classification code: N250



Type / Item	KRASO® FLS 90
InternalDiameter ID in mm	80
External diameter in mm	88
Bending radius in mm	200
Weight in kg/m ca.	1.5
Material thickness in mm	4
Compression resistance	629 N
Classification according to DIN EN 61386-24	N250 (reached test force F: 364 N)
Stock length in m	30
KRASO® FLS	22 € per metre
Cutting cost*	16 €

* without discount

Scope of supply: KRASO® FLS 90



Floor

Builder's Convenience Box - floor - garden (p. 56) +

Wall

Builder's Convenience Box - wall - garden (p. 59) +

Accessories

BKP - Garden - Extension Set (p. 56) +



Convenience
for the garden:
Multi utility
connection /
outlet

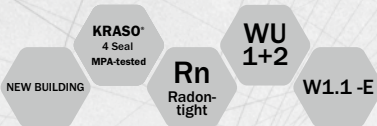

KRASO® Builder's Convenience Box - floor - garden

For more convenience in the garden!

- + Choose the **KRASO® Builder's Convenience Box - floor - garden** for any project in your garden or courtyard: lighting, pool, garden sauna, wall box for electric cars etc.
- + **For buildings without basement:** simple and tight routing of electricity, water and telecommunication lines from the utility connection space to the garden!
- + **KRASO® 4 Seal** : exterior sealing of concrete: **10 bar!** Radon-tight! Resistant to methane gas!
- + **Simple installation** due to the stable installation device and visual check of the snap-on socket – **helps to avoid installation errors!**
- + For flush-mount installation in the base plate – **no tripping hazards or wall damages!** Including building period protective cover.
- + **Easy integration of vapour barrier foils** due to the roughened trowel flange!
- + **Height-adjustable** base plate and floor screed
- + **Combinable with KRASO® Builder's Convenience Box - floor** as utility connection!
- + Including **KRASO® BKP - Sealing Insert - electricity + telecommunication!** clamping range: electricity 25 - 36 mm, telecommunication 2 x 5 - 10 mm, 3 x 7 - 14 mm
- + **Optionally available KRASO® BKP - Sealing Inserts:**
 - **KRASO® BKP - Sealing Insert - electricity/water**
 - **KRASO® BKP - Sealing Insert - telecommunication**
- + **DafStB waterproof concrete guideline: stress class 1 + 2, DIN 18533 W1.1 - E**

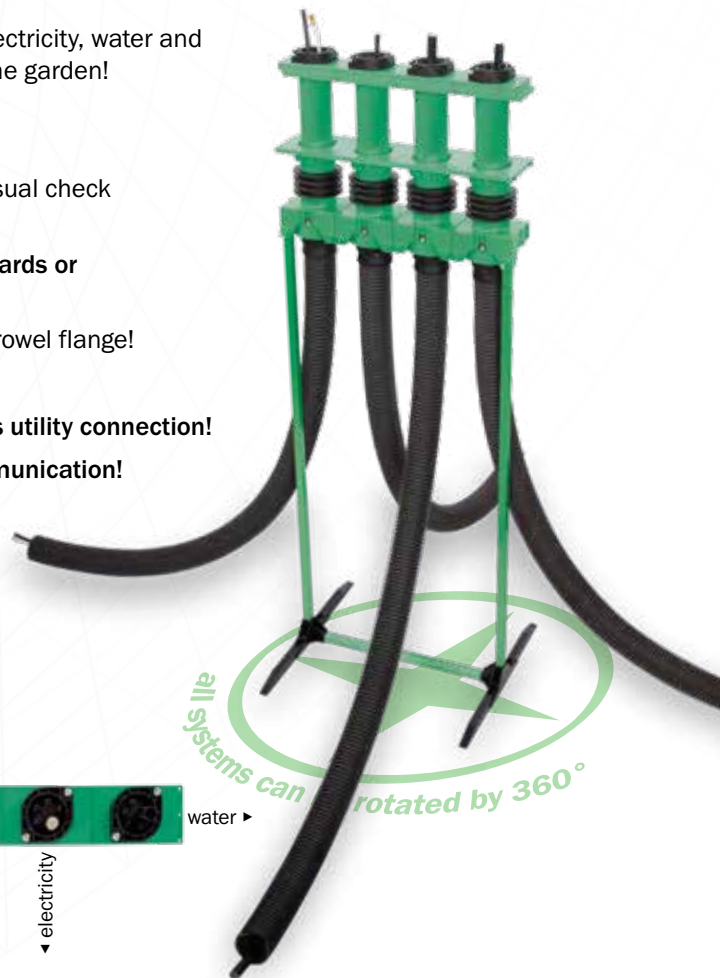
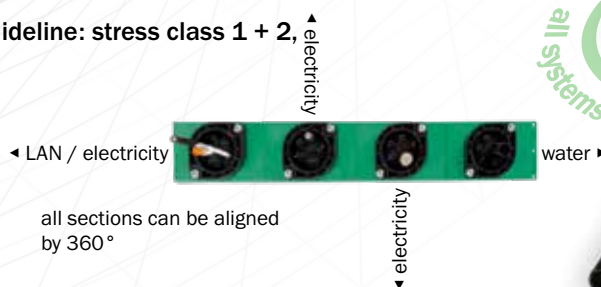



KRASO® BKP
 - floor - garden = 1 system
Adaptable!
 Combinable with further sections!
 Also combinable with KRASO® BKP - floor!

KRASO® Builder's Convenience Box - floor - garden **LG 5**

single utility connection / outlet for electricity, water or telecommunication for buildings without basement incl. cable protective hose (DN 75, 10 metres), incl. installation kits for electricity + telecommunication | **DafStB waterproof concrete guideline: stress class 1 + 2, DIN 18533 W1.1-E**

Type / Item	KRASO® BKP - floor - garden - 1-fold
Height-adjustable to TEUF* in mm from ... to ...	1350 - 1400
Height-adjustable to TEFF** in mm from ... to ...	12 - 280
Bending radius in mm	≥ 1000
Dimensions floor screed insert wiping edge in mm	141 x 90
Incl. cable protective hose DN 75	1 x 10 metres
KRASO® BKP - floor - garden - 1-fold	194 €

Scope of supply: KRASO® Builder's Convenience Box - floor - garden - 1-fold with cable protective hose (10 metres)

- foot
- foot extension
- pair of supporting bars
- height-adjustable base plate element 1-fold with gas- and water pressure tight **KRASO® 4 Seal**, trowel flange, visual check for locking sleeve and pre-installed building period installation cover
- height-adjustable **KRASO® BKP Floor Screed Insert** with protective cover and lubricant
- height fixation for **KRASO® BKP Floor Screed Insert**
- installation instructions **KRASO® Builder's Convenience Box - floor**
- folding rule
- installation kit including
 - **KRASO® BKP - Sealing Insert - electricity + telecommunication** - clamping range: electricity 25 - 36 mm / telecommunication 2 x 5 - 10 mm, 3 x 7 - 14 mm
 - primary sealing + secondary sealing electricity + telecommunication
 - casing pipe end plugs included
 - end plug electricity + telecommunication
 - hose connection 80
 - a tube of lubricant

* TEUF = Top Edge Unfinished Floor,

** TEFF = Top Edge Finished Floor



KRASO® BKP - garden - extension set **LG 5**

for the extension of the cable protective hoses of **KRASO® BKP - floor - garden** and **- wall - garden**, incl. 10 metres cable protective hose DN 75

Type / Item	KRASO® BKP - garden - extension set
KRASO® BKP - garden - extension set	60 €

Scope of supply: double sleeve DN 75, 2 sealing rings, 10 metres cable protective hose DN 75

Whether
inside or outside:
conveniently
connected

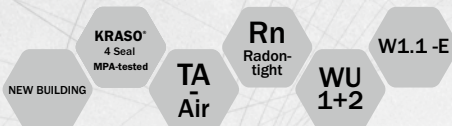

KRASO® Builder's Convenience Boxes for buildings without basement

The clever combination of utility connection
entries and outlets

- + **KRASO® Builder's Convenience Boxes for buildings without basement** can combine utility connection entries and outlets:
A clean solution for the utility connection space!
- + **Trendsetting:** flexible empty pipe systems and cable protective hoses in the **KRASO® Builder's Convenience Boxes** can be aligned in any direction by 360°!
- + **Easy installation** due to stable installation device and visual check of the snap-on-socket – **helps to avoid installation errors!**
- + For flush-mount installation in the base plate – **no tripping hazards, no wall damages!**
Including building period protective cover
- + Easy integration of vapour barrier foils due to the roughened trowel flange!
- + **Height-adjustable** base plate and floor screed
- + **Optionally available: KRASO® BKP - garden - extension set!**
- + **DafStB waterproof concrete guideline: stress class 1 + 2, DIN 18533 W1.1 -E**

utility
connection
entries and
outlets can be
combined!



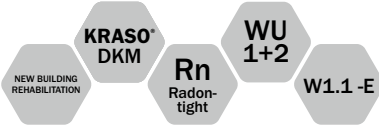

optionally available external sealing element

KRASO® Builder's Convenience Box - wall - garden

More convenience in the garden

- + Choose the **KRASO® Builder's Convenience Box - floor - garden** for any project in your garden or courtyard: lighting, pool, garden sauna, wall box for electric cars etc.
- + For core drilling and casing DN 200 (199 - 203 mm). **For precast walls and in-situ concrete walls!**
- + **Tight in waterproof concrete structures with stress class 1** (permanently or temporarily pressing water)
- + **Radon-tight! Resistant to methane gas!**
- + Torque Control Nut **KRASO® DKM: integrated torque limiter - no torque wrench required!**
- + Split end plugs for **easy installation!**
- + Ready for the utility connection of water, electricity and network lines: **tested in accordance with DVGW!** Including **KRASO® BKP - Sealing Inserts for electricity/water (2 x), telecommunication, electricity + telecommunication**
- + Optionally available: external sealing element with **flange according to DIN 18533!** Seal: 80 mm
- + **DafStB waterproof concrete guideline: stress class 1 + 2, with optional external sealing element DIN 18533 W1-E and W2.1-E**

KRASO® Builder's Convenience Box - wall - garden **LG5**

multi utility connection for electricity, water or telecommunication for buildings with basement, incl. installation kits for electricity/water (2 x), telecommunication, electricity + telecommunication | **DafStB waterproof concrete guideline: stress class 1 + 2, optional external sealing element DIN 18533 W1-E and W2.1-E**

Type / Item	KRASO® BKP - wall - garden
Wall thickness from ... to ...	200 - 500 mm
Diameter core drilling min ... max ...	199 - 203 mm
Length complete system	750 mm
Length x width internal sealing element	225 x 225 mm
Diameter external sealing element (optionally available)	300 mm
Internal diameter casing pipes	68 mm
External diameter casing pipes	75 mm
KRASO® BKP - wall - garden	554 €
Optional external sealing element	225 €

Scope of supply:

- **KRASO® Builder's Convenience Box - wall - garden** including
 - internal sealing element with pre-installed casing pipes incl. protective cover for the installation of supply lines such as water, electricity, telecommunication
- installation instructions **KRASO® Builder's Convenience Box - wall**
- folding rule
- installation kits including
 - **KRASO® BKP - Sealing Insert - electricity/water - 2 pcs.** with stepless onion ring technology 26 - 50 mm or blind
 - primary sealing + secondary sealing electricity/water
 - end plug
 - **KRASO® BKP - Sealing Insert - telecommunication -** clamping range: 5 - 13 mm, 3 x 7 - 13 mm, 13 - 21 mm
 - primary sealing + secondary sealing telecommunication
 - end plug
 - **KRASO® BKP - Sealing Insert - electricity + telecommunication -** clamping range: electricity 25 - 36 mm / telecommunication 2 x 5 - 10 mm, 3 x 7 - 14 mm
 - primary sealing + secondary sealing electricity + telecommunication
 - end plug
 - a tube of lubricant
- Optionally available: external sealing element



**Flexible Empty Pipe System
KRASO® FLS – sturdy and flexible!**

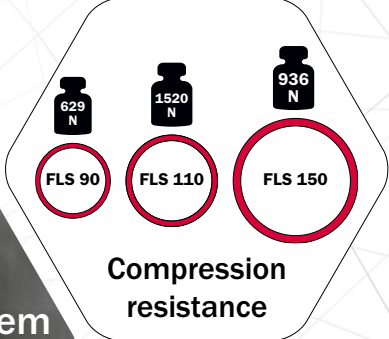

KRASO® FLS 90
spiral made of hard PVC



- + The Flexible Empty Pipe System **KRASO® FLS** is a cable protective hose which is a.o. part of the delivery of the **KRASO® Builder's Convenience Boxes** for buildings without basement. The **KRASO® FLS** can also be used as an extension.
- + **Compression resistance:** 629 Newton (**KRASO® FLS 90**) or 936 Newton (**KRASO® FLS 150**)
- + Tests according to **DIN EN 61386-24** lead to the following classifications:
compressive stress = type 250, impact resistance = normal, classification code = N250
- + Smooth interior and exterior, flexible, **enhanced pressure and vacuum resistance, high axial stability**, resistant to alkalis and acids, resistant to brine and sea water, good UV and ozone resister, gas-tight and liquid-tight, RoH-compliant (Restriction of Hazardous Substances)

- + You may receive a test certificate regarding the water pressure tightness for the majority of our products issued by an approved material testing. However, what does that mean?
- + Water pressure tightness is a theoretical value, stated in the unit "bar", providing information regarding the pressure at which a component remains water-tight.
- + With a so-called water column that is 10 metres high, the resulting pressure is 1 bar. At a height of 25 metres this is 2.5 bar, at 35 metres 3.5 bar, etc.

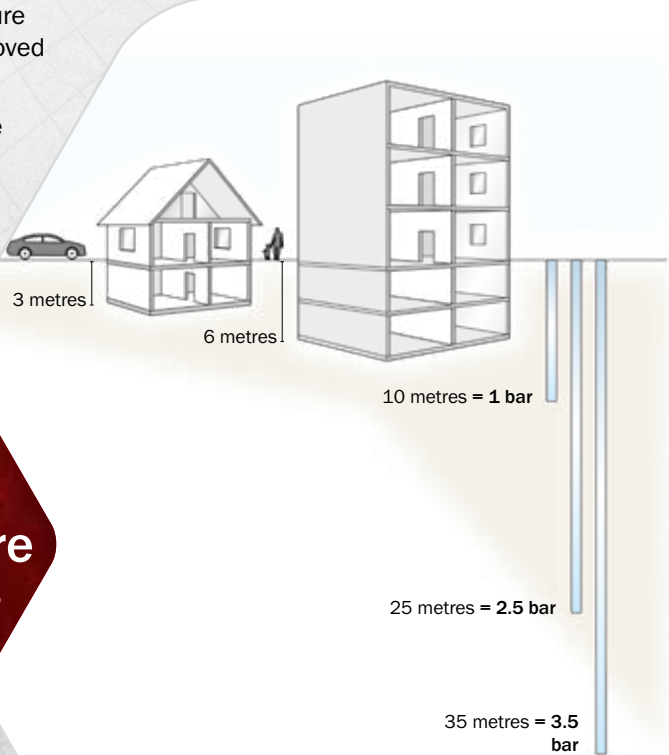

What does water pressure tight mean?

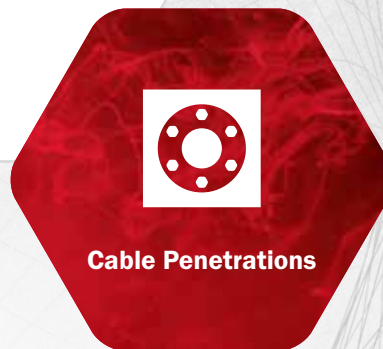

Cable Penetrations

Floor

Cable Inlet Box System KDS 150 (p. 67)

Wall

Cable Penetration KDS double wall penetration (p. 62) + Cable Penetration KDS single wall penetration (p. 63) + Cable Penetration KDS/DFW double wall penetration (p. 63) + Cable Penetration KDS/DFW single wall penetration (p. 64) + Cable Penetration KDS 150 single wall penetration with plug-in sleeve (p. 64) + Cable Penetration KDS 150 single wall penetration with hose connection (p. 64) + Cable Penetration KDS 150 double wall penetration with trowel flange (p. 65) + Cable Penetration KDS 150 single wall penetration with trowel flange (p. 65) + Protrusion Flange FDS 150 (p. 65) + Cable Penetration KDS 150 double wall penetration - 45 Grad (p. 66) + Cable Penetration KDS 150 FL/ZE double wall penetration (p. 66) + Cable Penetration KDS 150 FL/ZA (p. 66)

Roof

Swan Neck (p. 72) + Swan Neck - thermally insulated - (p. 73)

Accessories

FLS - Flexible Empty Pipe System (p. 68) + Quick Sealing Plug for FLS (p. 69) + Hose Connection (p. 69) + Spacer (p. 69) + System Sealing Insert KDS 150 Universal Multiple - split - (p. 69) + System Cover KDS 150 with hose adapter (p. 70) + System Cover KDS 150 with sleeve (p. 70) + System Cover KDS 150 - heat-shrink technology - (p. 70) + System Cover 90 with hose adapter 90 (p. 71) + Shrink Hose KDS 90 - 1-fold (p. 71) + System Sealing Insert KDS 90 Universal (p. 71) + Y-Wrench (p. 71) + Sealing Insert Universal Multiple - split - (p. 74)



KRASO® Cable Penetration KDS
Check the installation video
(just scan the QR code!)

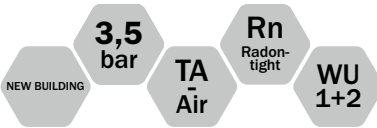
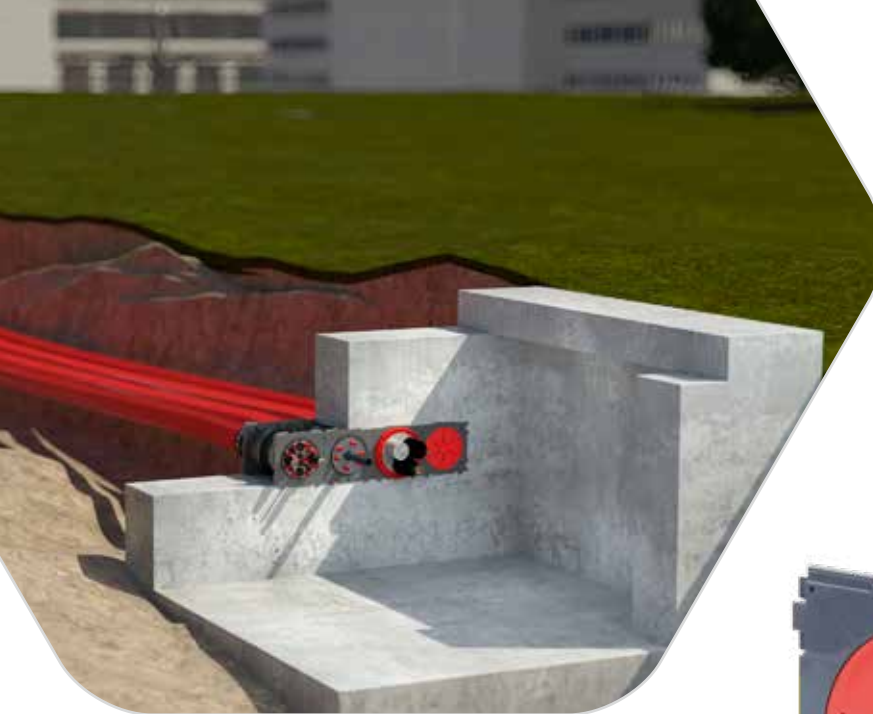

CABLE PENETRATIONS

KRASO® Cable Penetration KDS

Compatible, tight, secure –
the cable penetration double sealing system

- + **Compatible** with all other current systems! **Tight** due our water pressure **KRASO® 4 Seal !**
Secure due to break-resistant solid wall material!
- + **The intelligent, all-purpose and flexible cable penetration system** for complex new buildings:
public buildings, hospitals, technical-scientific institutions or in the **industrial and commercial sector.**
- + Horizontal and vertical combination possible, installation at an angle of 45° with pre-installed clamps possible, also available for precast walls or as integration into the sealing of larger areas.
- + The matching accessories for every purpose!
- + **DafStB waterproof concrete guideline: stress class 1 + 2**

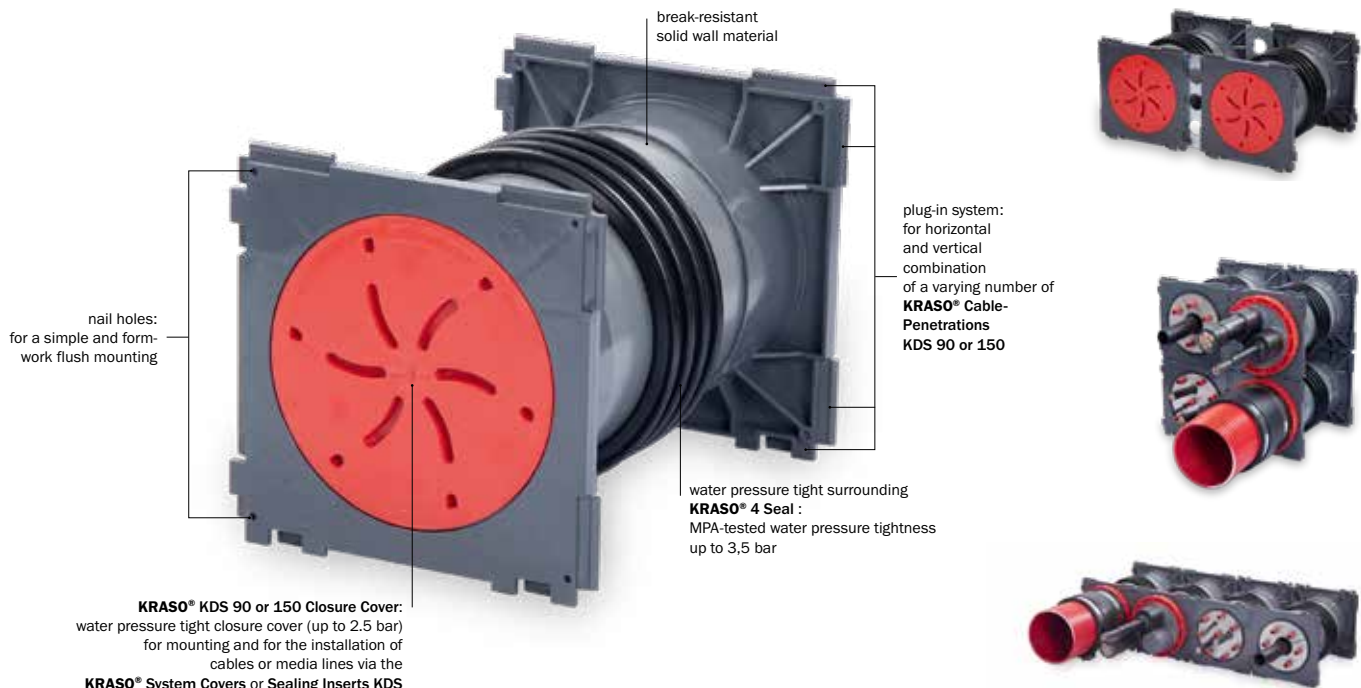

KRASO® KDS 90 or 150 Closure Cover:
water pressure tight closure cover (up to 2,5 bar)
for mounting and for the installation of
cables or media lines via the
KRASO® System Covers or Sealing Inserts KDS



KRASO® Spacer 40 mm for KDS 150 double wall penetration for the enlargement of the centre distance from 210 mm to 250 mm

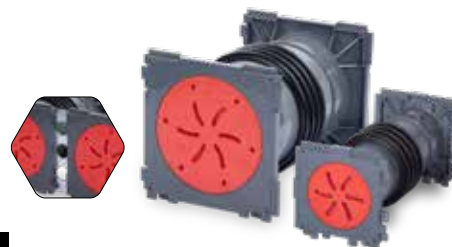

KRASO® Cable Penetration KDS double wall penetration **LG 1**

cable penetration system for concreting, with plug-in system on both sides for forming packages, for the later installation of media lines using a **KRASO® System Sealing Insert** (not included in the scope of supply) or for connecting empty pipe hoses using **KRASO® System Cover** (not included in the scope of supply). Optionally available: **KRASO® Spacer 40 mm** for KDS 150 double wall penetration for the enlargement of the centre distance from 210 mm to 250 mm | **DafStB waterproof concrete guideline: stress class 1 + 2**

Type / Item	KRASO® KDS double wall penetration											
Available standard wall thicknesses in cm	12	15	17,5	20	24	25	30	35	36,5	40	45	50
KRASO® KDS 90 double wall penetration	32 €											
KRASO® KDS 150 double wall penetration	37 €											
Surcharge per penetration: KRASO® Spacer 40 mm for KDS 150 double wall penetration	12 €											

Scope of supply: KRASO® Cable Penetration KDS 90 or 150 double wall penetration, 2 KDS Closure Covers • Optionally available: **KRASO® Spacer 40 mm** for KDS 150 double wall penetration, factory-assembled

Further wall thicknesses available on request!

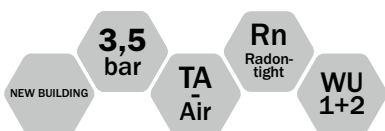

KRASO® Spacer 40 mm for KDS 150 single wall penetration for the enlargement of the centre distance from 210 mm to 250 mm



KRASO® Cable Penetration KDS single wall penetration **LG 1**

cable penetration system for concreting, with gas- and water pressure tight surrounding **KRASO® 4 Seal** and KDS closure covers, with plug-in system on one side for forming packages, for the later installation of media lines using a **KRASO® System Sealing Insert** (not included in the scope of supply) or for connecting empty pipe hoses using **KRASO® System Cover** (not included in the scope of supply). Optionally available: **KRASO® Spacer 40 mm** for KDS 150 single wall penetration for the enlargement of the centre distance from 210 mm to 250 mm | **DafStB waterproof concrete guideline: stress class 1 + 2**

Type / Item	KRASO® KDS single wall penetration													
Available standard wall thicknesses in cm	6 ^{1,2}	7 ²	10 ²	15	17,5	20	24	25	30	35	36,5	40	45	50
KRASO® KDS 90 single wall penetration	28 €													
KRASO® KDS 150 single wall penetration	32 €													
Surcharge per penetration: KRASO® Spacer 40 mm for KDS 150 single wall penetration	8 €													

¹ only for **KRASO® Cable Penetration KDS 90 single wall penetration**, ² for technical production reasons partly **KRASO® 2 Seal**

Scope of supply: KRASO® Cable Penetration KDS 90 or 150 single wall penetration, KDS closure cover, **KRASO® Cover** as an installation aid • Optionally available: **KRASO® Spacer 40 mm** for KDS 150 single wall penetration, factory-assembled

Further wall thicknesses available on request!

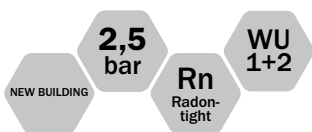

KRASO® Spacer 40 mm for KDS/DFW 150 double wall penetration for the enlargement of the centre distance from 210 mm to 250 mm



KRASO® Cable Penetration KDS/DFW double wall penetration **LG 1**

cable penetration system for installation into triple walls, with gas- and water pressure tight surrounding **KRASO® 2 Seal** on both sides and 2 KDS closure cover, with plug-in system on both sides for forming packages, for the later installation of media lines using a **KRASO® System Sealing Insert** (not included in the scope of supply) or for connecting empty pipe hoses using **KRASO® System Cover** (not included in the scope of supply). Optionally available: **KRASO® Spacer 40 mm** for KDS/DFW 150 double wall penetration for the enlargement of the centre distance from 210 mm to 250 mm | **DafStB waterproof concrete guideline: stress class 1 + 2**

Type / Item	KRASO® KDS/DFW double wall penetration										
Available standard wall thicknesses in cm	15	17,5	20	24	25	30	35	36,5	40	45	50
KRASO® KDS/DFW 90 double wall penetration	32 €										
KRASO® KDS/DFW 150 double wall penetration	37 €										
Surcharge per penetration: KRASO® Spacer 40 mm for KDS/DFW 150 double wall penetration	12 €										

Scope of supply: KRASO® Cable Penetration KDS/DFW 90 or 150 double wall penetration, 2 KDS Closure Covers • Optionally available: **KRASO® Spacer 40 mm** for KDS/DFW 150 double wall penetration, factory-assembled

Further wall thicknesses available on request!



KRASO® Spacer 40 mm for KDS/DFW 150 single wall penetration for the enlargement of the centre distance from 210 mm to 250 mm

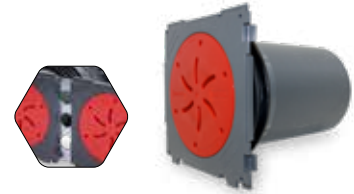

KRASO® Cable Penetration KDS/DFW single wall penetration **LG1**

cable penetration system for installation into triple walls, with gas- and water pressure tight surrounding **KRASO® 2 Seal** on one side and KDS closure cover, with plug-in system on both sides for forming packages, for the later installation of media lines using a **KRASO® System Sealing Insert** (not included in the scope of supply) or for connecting empty pipe hoses using **KRASO® System Cover** (not included in the scope of supply). Optionally available: **KRASO® Spacer 40 mm** for KDS/DFW 150 single wall penetration for the enlargement of the centre distance from 210 mm to 250 mm | **DafStB waterproof concrete guideline: stress class 1 + 2**

Type / Item	KRASO® KDS/DFW single wall penetration													
Available standard wall thicknesses in cm	6 ¹	7	10	15	17,5	20	24	25	30	35	36,5	40	45	50
KRASO® KDS/DFW 90 single wall penetration	28 €													
KRASO® KDS/DFW 150 single wall penetration	37 €													
Surcharge per penetration: KRASO® Spacer 40 mm for KDS/DFW 150 single wall penetration	8 €													

¹ only for **KRASO® Cable Penetration KDS/DFW 90 single wall penetration**

Scope of supply: **KRASO® Cable Penetration KDS/DFW 90 or 150 single wall penetration**, KDS closure cover, **KRASO® Cover** as an installation aid • Optionally available: **KRASO® Spacer 40 mm for KDS/DFW 150 single wall penetration**, factory-assembled

Further wall thicknesses available on request!

CABLE PENETRATIONS



KRASO® Cable Penetration KDS 150 single wall penetration with plug-in sleeve **LG1**

for later installation of cables or pipes using **KRASO® System Sealing Insert KDS 150** (not included in the scope of supply) or **KRASO® System Cover KDS 150** (not included in the scope of supply), with water pressure tight surrounding **KRASO® 4 Seal**, with plug-in system on one side for forming packages, one side with plug-in sleeve including connection for from KG, HT or KG 2000 pipes DN 160 | **DafStB waterproof concrete guideline: stress class 1 + 2**

Type / Item	KRASO® KDS 150 single wall penetration with plug-in sleeve									
Available standard wall thicknesses in cm	20	24	25	30	35	36,5	40	45	50	
KRASO® KDS 150 single wall penetration with plug-in sleeve	46 €									

Scope of supply: **KRASO® Cable Penetration KDS 150 single wall penetration with plug-in sleeve**, KDS 150 Closure Cover and **KRASO® Cover** as an installation aid

Further wall thicknesses available on request!

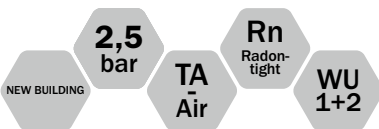

KRASO® Cable Penetration KDS 150 single wall penetration with hose connection **LG1**

for later installation of cables or pipes using **KRASO® System Sealing Insert KDS 150** (not included in the scope of supply) or **KRASO® System Cover KDS 150** (not included in the scope of supply), with water pressure tight surrounding **KRASO® 4 Seal**, with plug-in system on one side for forming packages, one side with hose connection e.g. for **KRASO® FLS - Flexible Empty Pipe System** | **DafStB waterproof concrete guideline: stress class 1 + 2**

Type / Item	KRASO® KDS 150 single wall penetration with hose connection									
Available standard wall thicknesses in cm	20	24	25	30	35	36,5	40	45	50	
KRASO® KDS 150 single wall penetration with hose connection 110	108 €									
KRASO® KDS 150 single wall penetration with hose connection 160	111 €									

Scope of supply: **KRASO® Cable Penetration KDS 150 single wall penetration with hose connection**

Further wall thicknesses available on request!

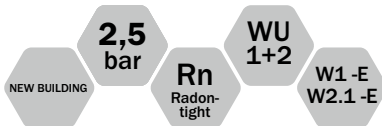

KRASO® Cable Penetration KDS 150 double wall penetration with trowel flange also for forming a package



trowel flange roughened
trowel flange tissue coated



KRASO® Cable Penetration KDS 150 double wall penetration with trowel flange **LG 1**

cable penetration system for concreting, with gas- and water pressure tight surrounding KRASO® 4 Seal , incl. 2 KDS closure cover, with trowel flange, tissue coated or roughened, surrounding approx. 7 cm for a secure connection of bitumen or reactive sealing (e.g. KMB) or a fresh concrete composite system, for later installation of media lines using KRASO® System Sealing Insert KDS or for connecting empty pipe hoses using KRASO® System Cover | DafStB waterproof concrete guideline: stress class 1 + 2, DIN 18533 W1 -E and W2.1 -E

Type / Item	KRASO® KDS 150 double wall penetration with trowel flange										
Available standard wall thicknesses in cm	15	17,5	20	24	25	30	35	36,5	40	45	50
KRASO® KDS 150 double wall penetration with trowel flange - R -	82 €										
KRASO® KDS 150 double wall penetration with trowel flange - G -	92 €										

Scope of supply: KRASO® Cable Penetration KDS 150 double wall penetration with trowel flange, 2 KDS closure covers

Further wall thicknesses available on request!

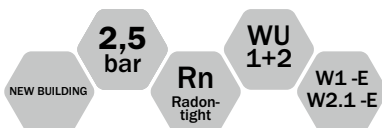

trowel flange roughened
trowel flange tissue coated



KRASO® Cable Penetration KDS 150 single wall penetration with trowel flange **LG 1**

cable penetration system for concreting, with gas- and water pressure tight surrounding KRASO® 4 Seal , incl. KDS closure covers, with trowel flange, tissue coated or roughened, surrounding approx. 7 cm, for a secure connection of bitumen and reactive sealings or a fresh concrete composite system, for later installation of media lines using KRASO® System Sealing Insert KDS or for connecting empty pipe hoses using KRASO® System Cover | DafStB waterproof concrete guideline: stress class 1 + 2, DIN 18533 W1 -E and W2.1 -E

Type / Item	KRASO® KDS 150 single wall penetration with trowel flange										
Available standard wall thicknesses in cm	15	17,5	20	24	25	30	35	36,5	40	45	50
KRASO® KDS 150 single wall penetration with trowel flange - R -	77 €										
KRASO® KDS 150 single wall penetration with trowel flange - G -	87 €										

Scope of supply: KRASO® Cable Penetration KDS 150 single wall penetration with trowel flange, KDS Closure Cover

Further wall thicknesses available on request!

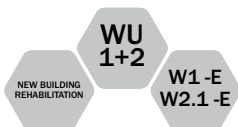

KRASO® Protrusion Flange FDS 150 **LG 1**

protrusion flange made of stainless steel-reinforced plastic, for dowel-fixing in front of a core drilling for the connection of KRASO® System Cover KDS 150 with hose adapter for KRASO® FLS, KRASO® System Sealing Insert KDS 150 | DafStB waterproof concrete guideline: stress class 1 + 2, DIN 18533 W1 -E and W2.1 -E

Type / Item	KRASO® Protrusion Flange FDS 150
KRASO® Protrusion Flange FDS 150	110 €

Scope of supply: KRASO® Protrusion Flange FDS 150 with EPDM flat seal and fixing material

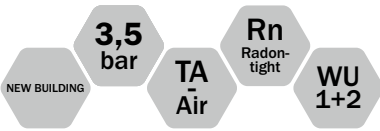

KRASO® Cable Penetration KDS 150 double wall penetration - 45 degrees -

with pre-installed clamps and styrofoam holders for installation at an angle of 45° | DafStB waterproof concrete guideline: stress class 1 + 2

Prices on request! Further inclination angles available on request!

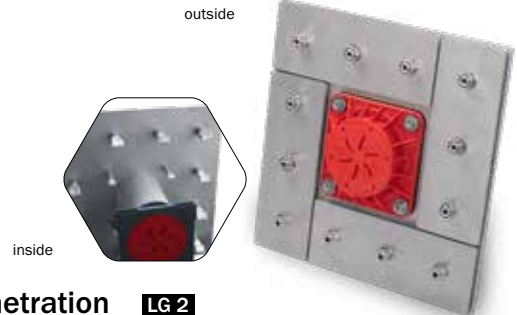

KRASO® Cable Penetration KDS 150 FL/ZE double wall penetration **LG 2**

cable penetration KDS 150 FL/ZE as double wall penetration, with fixed-loose flange and exterior protrusion flange FDS 150 for concreting, for installation of media pipes using KRASO® Sealing Inserts KDS 150 (not included in the scope of supply) or for connection of KRASO® KDS 150 Accessories (e.g. system cover) with bayonet fitting, made of non-corrosive stainless steel V2A, one side with water pressure tight surrounding KRASO® 2 Seal, for buildings with exterior sealing („black tank“) against pressing / non-pressing water according to DIN 18533. Available in non-corrosive stainless steel V2A or with special coating | DIN 18533 W2.1 -E and W2.2 -E

KRASO® Cable Penetration KDS 150 FL/ZE double wall penetration - DIN 18533 W2.2 -E: HIGH IMPACT OF PRESSING WATER (WATER COLUMN ≥ 3 METRES)

Pipe InternalDiameter ID	155
Available standard wall thicknesses in cm	15 • 17,5 • 20 • 24 • 25 • 30 • 35 • 36,5 • 40 • 45 • 50
Dimensions fixed-flange	Dimensions a x b 577 mm - t = 10 mm
Dimensions loose-flange	Dimensions a x b 567 mm - t = 10 mm
KRASO® KDS 150 FL/ZE double wall penetration - non-corrosive stainless steel V2A -	1.251 €
EPDM supplement (2 pcs.)	69 €
KRASO® KDS 150 FL/ZE double wall penetration with special coating - non-corrosive stainless steel V2A -	1.325 €

KRASO® Cable Penetration KDS 150 FL/ZE double wall penetration - DIN 18533 W2.1 -E: MEDIUM IMPACT OF PRESSING WATER (WATER COLUMN ≤ 3 METRES)

Pipe InternalDiameter ID	155
Available standard wall thicknesses in cm	15 • 17,5 • 20 • 24 • 25 • 30 • 35 • 36,5 • 40 • 45 • 50
Dimensions fixed-flange	Dimensions a x b 397 mm - t = 6 mm
Dimensions loose-flange	Dimensions a x b 387 mm - t = 6 mm
KRASO® KDS 150 FL/ZE double wall penetration - non-corrosive stainless steel V2A -	898 €
EPDM supplement (2 pcs.)	50 €
KRASO® KDS 150 FL/ZE double wall penetration with special coating - non-corrosive stainless steel V2A -	966 €

Scope of supply: KRASO® Cable Penetration KDS 150 FL/ZE double wall penetration, with fixed-loose flange and exterior KRASO® Protrusion Flange FDS 150, 2 KDS 150 closure covers

Further wall thicknesses available on request lieferbar! Also available in V4A! Also available as formed packages!



KRASO® Cable Penetration KDS 150 FL/ZE as multiple wall penetration - 45 degrees, for concreting (special production)



KRASO® Cable Penetration KDS 150 FL/ZA as multiple wall penetration - with fixed-loose flange and exterior protrusion flange FDS 150, for dowel-fixing (special production)



KRASO® Cable Inlet Box System KDS
Check the installation video
(just scan the QR code!)

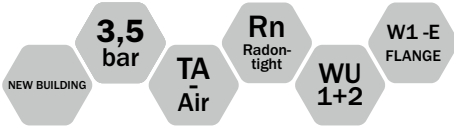

KRASO® Cable Inlet Box System KDS 150

The flexible system for industry and commercial buildings

- + **The secure and reliable way for the installation of cables and pipes right into buildings:** with a radius of 650 mm or 1000 mm, main pipes and cable protective hoses can be connected at a 90-degree angle to buildings without basements
- + **KRASO® Cable Penetration System KDS 150:** flexible and combinable in various ways
- + The **KRASO® Cable Inlet Box System KDS 150** can be expanded to any number of rows thanks to the plug-in system - depending on your requirements!
- + **For the installation of cables and pipes such as water, electricity, telecommunication etc. into buildings without a basement:** the perfect solution for industrial and commercial buildings!
- + **Sealing of the base plate** by water pressure tight surrounding **KRASO® 4 Seal**
- + **With stable installation device** for correct positioning before concreting
- + Flexible plug-in possibilities on the outer side using **KRASO® Cable Penetration System KDS 150**
- + Additional media pipe sealing from the inside using **KRASO® Sealing Inserts**
- + **Included in the scope of supply:** **KRASO® KDS 150 Empty Pipe Insert** with bayonet fitting for a floor construction with floor heating, insulation and screed
- + **DafStB waterproof concrete guideline:** stress class **1 + 2**, with optional trowel flange DIN 18533 W1 -E

KRASO® Cable Inlet Box System KDS 150 available with **KRASO® Trowel Flange** roughened plastic-trowel flange for the integration into the floor sealing/ sealing sheets

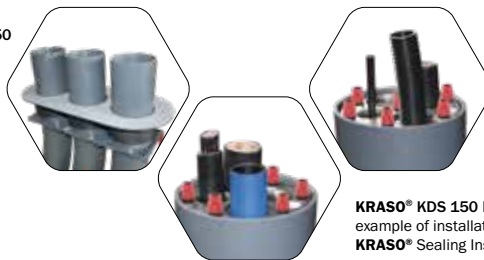

KRASO® KDS 150 Empty Pipe Insert example of installation of media lines using **KRASO® Sealing Inserts**

KRASO® Cable Inlet Box System KDS 150 **LG 2**

for the installation of cables and utility lines such as e.g. water - electricity - telecommunication etc. in buildings without basement. Attention: do not use a **KRASO® System Sealing Insert KDS 150** for the sealing of media lines, but use **KRASO® Sealing Inserts** instead (s. p. 11 - 15)! | **DafStB waterproof concrete guideline:** stress class **1 + 2**, with optional trowel flange DIN 18533 W1 -E

Type / Item	KRASO® Cable Inlet Box System KDS 150			
Available standard systems	1 x 1	1 x 2	1 x 3	1 x 4
KRASO® Cable Inlet Box System KDS 150 - bending radius 650 mm	561 €	691 €	804 €	906 €
KRASO® Cable Inlet Box System KDS 150 - bending radius 1000 mm	627 €	774 €	901 €	1.015 €

Scope of supply: **KRASO® Cable Inlet Box System KDS 150**, **KRASO® KDS 150 Empty Pipe Insert 25 cm**, 90° empty pipe system, installation device and KDS 150 Closure Cover

Further combinations available on request!



KRASO® KDS - Accessories

Appropriate accessories for KRASO® Cable Penetration KDS + Cable Inlet Box System KDS 150

- + With the appropriate accessories, **KRASO® Cable Penetration KDS 90 / KDS 150** as wall penetrations and **KRASO® Cable Inlet Box System KDS 150** can be combined to a complete individual system – as it is required for challenging construction projects
- + Our experts are happy to assist you regarding the numerous possibilities – even on your construction-site!

KRASO® FLS – sturdy and flexible!

KRASO® FLS 90
hard PVC spiral

629 N
FLS 90

1520 N
FLS 110

936 N
FLS 150

Compression resistance

NEW BUILDING

KRASO® FLS - Flexible Empty Pipe System **LG 4**

flexible empty pipe system as a cable protective hose for gas- and water tight connection to **KRASO® Cable Penetration KDS**, over-pressures of 4.0 or 3 bar, under-pressures of 0.7 or 0.5 bar, heavy design for high mechanical load, smooth interior for smooth cable pulling, smooth exterior for optimal sealing, flexible, enhanced resistance against pressure and vacuum, high axial resistance, resistant to alkalis and acids, resistant to brine and sea water, good UV and ozone resistance, gas-tight and liquid-tight, RoHS compliant (*Restriction of Hazardous Substances*)

Type / Item	KRASO® FLS 90	KRASO® FLS 110*	KRASO® FLS 150* **
InternalDiameter ID in mm	80	101	150
External diameter in mm	88	113	163
Bending radius in mm	200	350	600
Weight in kg/m ca.	1.5	2,9	4,3
Material thickness in mm	4	6	6,5
Compression resistance	629 N	1520 N	936 N
Classification according to DIN EN 61386-24	N250 (reached test force F: 364 N)	N250 (reached test force F: 293 N)	N250 (reached test force F: 388 N)
Stock length in m	30	30	20
KRASO® FLS	22 € per metre	33 € per metre	43 € per metre
Cutting cost***	16 €	22 €	-

* Minimum order 10 m ** Freight charges for KRASO® FLS 150 only on request *** no discount applicable

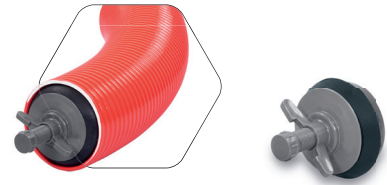

KRASO® Quick Sealing Plug for FLS **LG 1**

for sealing the KRASO® FLS - Flexible Empty Pipe System

Type / Item	KRASO® Quick Sealing Plug for FLS		
FLS	FLS 90	FLS 110	FLS 150
KRASO® Quick Sealing Plug for FLS	44 €	50 €	62 €

Further diameters available on request!



KRASO® Hose Connection **LG 1**

for the connection of e.g. KRASO® FLS - Flexible Empty Pipe System

Type / Item	KRASO® Hose Connection			
Diameter DN	90	110	125	150
KRASO® Hose Connection	50 €	68 €	71 €	75 €



KRASO® Spacer **LG 1**

guarantees sufficient distance between the flexible empty pipes, lighter, impact resistant, weather- and rot-proof plastic spacer

Type / Item	KRASO® Spacer 110	KRASO® Spacer 150
InternalDiameter ID in mm	110	165
KRASO® Spacer 1 x 2	14 €	15 €
KRASO® Spacer 2 x 2	18 €	19 €
KRASO® Spacer 2 x 4	23 €	24 €

Further spacers available on request!

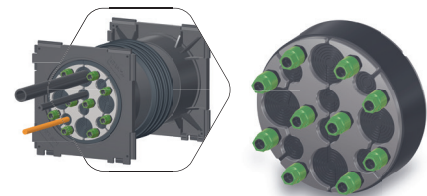

KRASO® System Sealing Insert KDS 150 Universal Multiple - split - **LG 1**

can be used for installation of one or several media lines/cables, for installation into the bayonet fitting of KRASO® Cable Penetration KDS 150, split design for retrofit installation, Torque Control Nut KRASO® DKM, 30 mm seal, external diameter 160 mm, specifically for the use in cable penetrations | DafStB waterproof concrete guideline: stress class 1 + 2

KRASO® System Sealing Insert KDS 150 Universal Multiple - split -				
	Universal	Design 1	Design 2	Design 3
Drillings or stepless onion ring technology: external cable diameter from... to ... in mm	1 x 63, 75, 90 or 110 mm	3 x 6 - 52 mm or blind	4 x 6 - 18 mm or blind 6 x 6 - 33 mm or blind	6 x 6 - 38 mm or blind
KRASO® System Sealing Insert KDS 150 Universal Multiple - split -	107 €	127 €	127 €	127 €

Further special designs on request!

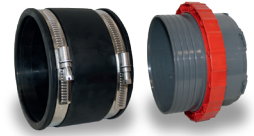

KRASO® System Cover KDS 150 with hose adapter **LG 1**

incl. bayonet fitting with union nut and anti-twist lock, hose adapter for the connection of **KRASO®** FLS, PE corrugated pipes or PVC and PP pipes to **KRASO®** Cable Penetration KDS 150. In combination with **KRASO®** FLS water pressure tight up to 2.5 bar. Scope of application as per table below | **DafStB waterproof concrete guideline: stress class 1 + 2**

Type / Item	hose adapter 110	hose adapter 160
Scope of application in mm	100 - 115	150 - 165
KRASO® System Cover KDS 150 with hose adapter	81 €	88 €

Scope of supply: KRASO® System Cover 150 with hose adapter



KRASO® System Cover KDS 150 with sleeve **LG 1**

incl. bayonet fitting with union nut and anti-twist lock, sleeve for the connection of PVC and PP pipes to **KRASO®** Cable Penetration KDS 150

Type / Item	KRASO® System Cover KDS 150 with sleeve		
Diameter DN	110	125	160
KRASO® System Cover KDS 150 with sleeve	75 €	80 €	82 €

Scope of supply: KRASO® System Cover 150 with sleeve

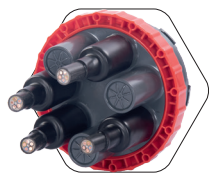

KRASO® System Cover KDS 150 - heat-shrink technology - **LG 1**

incl. bayonet fitting with union nut and anti-twist lock (prevents unintentional opening), with 1, 3 or 7 adapters for installation of pipes or cables, incl. shrink hose (length approx. 20 cm), connection via heat-shrink technology, **KRASO® System Cover KDS 150 - heat-shrink technology - 3-fold and 7-fold** with factory-installed, water pressure tight cover, simple opening by knocking off before installation (on-site), scope of application as per table below | **DafStB waterproof concrete guideline: stress class 1 + 2**

Type / Item	System Cover KDS 150 1-fold - heat-shrink technology -	System Cover KDS 150 3-fold - heat-shrink technology -	System Cover KDS 150 7-fold - heat-shrink technology -
diameter pipe or cable from ... to ... in mm	1 x 34 - 115	3 x 22 - 59	7 x 13 - 33
KRASO® System Cover KDS 150 - heat-shrink technology -	91 €	100 €	112 €

Scope of supply: KRASO® System Cover KDS 150 - heat-shrink technology - 1-fold, 3-fold, 7-fold with shrink hose/shrink hoses

Further diameters on request!



KRASO® System Cover 90 with hose adapter 90 **LG1**

incl. bayonet fitting, hose adapter for connection of **KRASO®** FLS, PE corrugated pipes or PVC-pipes to **KRASO®** Cable Penetration KDS 90 | **DafStB** waterproof concrete guideline: stress class 1 + 2

Type / Item	KRASO® System Cover 90 with hose adapter 90
Scope of application in mm	80 - 95
KRASO® System Cover 90 with hose adapter 90	79 €

Scope of supply: **KRASO®** System Cover 90 with hose adapter 90



KRASO® Shrink Hose KDS 90 - 1-fold **LG1**

shrink hose for **KRASO®** System Cover 90 (incl.)

Type / Item	KRASO® Shrink Hose KDS 90 - 1-fold
KRASO® Shrink Hose KDS 90 - 1-fold for all pipes and cables according to the table on the right (in mm)	1 x 25 - 95
KRASO® Shrink Hose KDS 90 - 1-fold	41 €

Scope of supply: **KRASO®** Shrink Hose KDS 90 - 1-fold, **KRASO®** System Cover 90

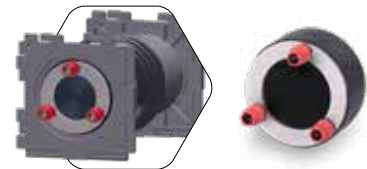
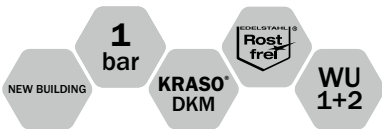

KRASO® System Sealing Insert KDS 90 Universal **LG1**

system sealing insert especially for connection of **KRASO®** Cable Penetration KDS 90, 20 mm seal, against pressing water up to 1 bar, Torque Control Nut **KRASO®** DKM, non-corrosive stainless steel V2A. Also usable as blind plug until feed-through of pipes or cables | **DafStB** waterproof concrete guideline: stress class 1 + 2

Type / Item	KRASO® System Sealing Insert KDS 90 Universal
Stepless onion ring technology: external cable diameter from... to ... in mm	6 - 52 mm or blind
KRASO® System Sealing Insert KDS 90 Universal	79 €
KRASO® System Sealing Insert KDS 90 Universal - split -	88 €

Further special designs on request!



KRASO® Y-Wrench **LG1**

Y-Wrench to open/close the KDS closure cover, available for **KRASO®** Cable Penetration KDS 90 and KDS 150

Type / Item	KRASO® Y-Wrench
KRASO® Y-Wrench 90	50 €
KRASO® Y-Wrench 150	59 €



KRASO® Swan Neck
Check the installation video
(just scan the QR code!)



EPDM



Thermofol U15



FPO



RESITRIX®



PP



PE



KRASO®-Fol



PYE-PV 200 S5

KRASO® Swan Neck

Innovative, secure, tight – the KRASO® Flat Roof Penetration

- + Integration in the roof sealing sheeting using **KRASO® Foil Clamping Flange Type FKF**: oil- and bitumen resistant, tested water pressure tightness up to 2.5 bar
- + Torque Control Nut **KRASO® DKM**: integrated torque limiter - no torque wrench required!
- + **UV protection** with surrounding peripheral drip edge and anti-twist lock
- + **Can be swivelled by 360 degrees!**
- + Flat roof penetration available **galvanised, non-corrosive stainless steel V2A or stainless steel V4A**
Also available as thermally insulated version!
- + We can adjust the **type of sealing sheets or foils**:
e.g. EPDM, Thermofol U15, FPO, RESITRIX®, PP, PE, **KRASO®-Fol**, PYE-PV 200 S5 etc.
- + **Included in the scope of supply**: fastening dowels M8 x 100 V2A and EPDM sealing, adhesive and sealant **KRASO® PU 50**.



UV protection with surrounding peripheral drip edge at the underside, anti-twist lock, **KRASO® Foil Clamping Flange Type FKF**



second sealing layer possible



cables can be sealed off without any problems by using **KRASO® Sealing Insert Universal Multiple - split -** (see page 74)



UV protection with surrounding peripheral drip edge at the underside, anti-twist lock



with innovative foil clamping flange sealing instead of drip cover



KRASO® Swan Neck **LG 2**

flat roof penetration for installation of cables using KRASO® Sealing Insert Universal Multiple - split - (not included in the scope of supply), integration in the roof sealing sheeting using KRASO® Foil Clamping Flange Type FKF

Type / Item	KRASO® Swan Neck			
Nominal Width NW	100*	150*	200*	300**
	Diameter pipe or cable from ... to ... in mm			
Design 1	4 x 6 - 33 mm or blind	3 x 6 - 52 mm or blind	3 x 6 - 28 mm or blind 4 x 6 - 52 mm or blind	e.g. 3 x 0 - 110 or 5 x 0 - 85 or 9 x 0 - 63
Design 2	3 x 6 - 18 mm or blind 2 x 6 - 33 mm or blind	4 x 6 - 18 mm or blind 6 x 6 - 33 mm or blind	7 x 6 - 18 mm or blind 8 x 6 - 33 mm or blind	
Design 3	8 x 6 - 18 mm or blind	6 x 6 - 38 mm or blind	-	
KRASO® Swan Neck - galvanised -	799 €	937 €	1.290 €	1.776 €
KRASO® Swan Neck - non-corrosive stainless steel V2A -	999 €	1.172 €	1.612 €	2.221 €
Surcharge: second sealing layer	233 €	326 €	408 €	764 €

* KRASO® Sealing Insert Universal Multiple - split - (not included in the scope of supply) ** KRASO® Sealing Insert SD - split - (not included in the scope of supply)

Scope of supply: KRASO® Swan Neck, EPDM seal, KRASO® Foil Clamping Flange Type FKF, UV protection, fastening dowels M8 x 100 V2A, adhesive and sealant KRASO® PU 50

Further sizes available on request!

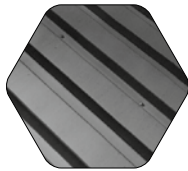

**Mounting possibilities
for trapezoidal sheet
roofs on request!**



KRASO® Swan Neck - thermally insulated - **LG 2**

flat roof penetration, for dowel-fixing, for installation of cables using KRASO® Sealing Insert Universal Multiple - split - (not included in the scope of supply), can be swivelled by 360°, integration in the roof sealing sheeting using KRASO® Foil Clamping Flange Type FKF, oil- and bitumen resistant, Torque Control Nut KRASO® DKM, UV protection with surrounding peripheral drip edge and anti-twist lock, with EPDM seal for foot seal of the roof opening

Type / Item	KRASO® Swan Neck - thermally insulated -			
Nominal Width NW	100*	150*	200*	300**
	Diameter pipe or cable from ... to ... in mm			
Design 1	4 x 6 - 33 mm or blind	3 x 6 - 52 mm or blind	3 x 6 - 28 mm or blind 4 x 6 - 52 mm or blind	e.g. 3 x 0 - 110 or 5 x 0 - 85 or 9 x 0 - 63
Design 2	3 x 6 - 18 mm or blind 2 x 6 - 33 mm or blind	4 x 6 - 18 mm or blind 6 x 6 - 33 mm or blind	7 x 6 - 18 mm or blind 8 x 6 - 33 mm or blind	
Design 3	8 x 6 - 18 mm or blind	6 x 6 - 38 mm or blind	-	
KRASO® Swan Neck - thermally insulated - galvanised -	1.386 €	1.719 €	2.301 €	2.813 €
KRASO® Swan Neck - thermally insulated - non-corrosive stainless steel V2A -	1.871 €	2.322 €	3.107 €	3.797 €
Surcharge: second sealing layer	317 €	395 €	539 €	887 €

* KRASO® Sealing Insert Universal Multiple - split - (not included in the scope of supply) ** KRASO® Sealing Insert SD - split - (not included in the scope of supply)

Scope of supply: KRASO® Swan Neck - thermally insulated -, EPDM seal, KRASO® Foil Clamping Flange Type FKF, UV protection, fastening dowels M8 x 100 V2A, adhesive and sealant KRASO® PU 50

Further sizes available on request! Mounting possibility for trapezoidal sheet roofs on request!

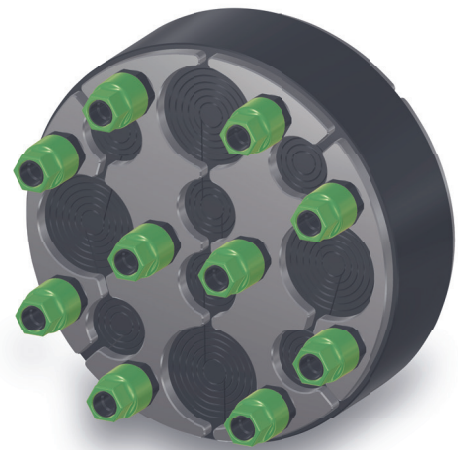
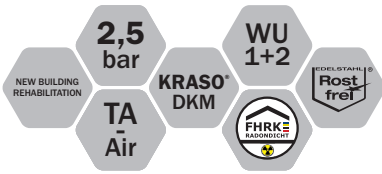

KRASO® Sealing Insert Universal Multiple - split - Usable anywhere – extremely flexible

- + For core drillings and casings.
- + **Stepless onion ring technology:** usable for any external diameter of media lines/cables - even with several penetrations! Split design for retrofit installation!
- + **KRASO® Sealing Insert quality:** 5 mm thick clamping plates made of non-corrosive stainless steel V2A, 40 mm seal made of specially developed rubber mixture, welded-on studs instead of through bolts.
- + Torque Control Nut **KRASO® DKM:** integrated torque limiter - no torque wrench required!
- + **MPA-tested:** protects reliably against pressing water up to 2.5 bar!
- + **Gas- and odour-tight** – high-quality in terms of TA-Air!
- + **Radon tightness IAF tested** - meets the requirements for radon precautionary areas according to FHRK leaflet MB 101!
- + **DafStB waterproof concrete guideline: stress class 1 + 2**

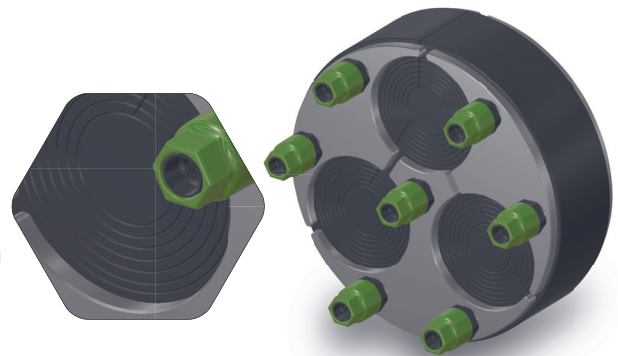

Stepless onion ring technology!
example:
KRASO® Sealing Insert Universal Multiple 150 - split - Design 1:
3 x 6 - 52 mm or blind

KRASO® Sealing Insert Universal Multiple - split - **LG 1**

for simultaneous installation of several media lines/cables, split design for retrofit installation | DafStB waterproof concrete guideline: stress class 1 + 2

Type / Item	KRASO® Sealing Insert Universal Multiple - split -			
Core drilling / casing in mm	100	125	150	200
	Stepless onion ring technology: external cable diameter from... to ... in mm			
Design 1	4 x 6 - 33 mm or blind	6 x 6 - 28 mm or blind	3 x 6 - 52 mm or blind	3 x 6 - 28 mm or blind 4 x 6 - 52 mm or blind
Design 2	3 x 6 - 18 mm or blind 2 x 6 - 33 mm or blind	-	4 x 6 - 18 mm or blind 6 x 6 - 33 mm or blind	7 x 6 - 18 mm or blind 8 x 6 - 33 mm or blind
Design 3	8 x 6 - 18 mm or blind	-	6 x 6 - 38 mm or blind	-
KRASO® Sealing Insert Universal Multiple - split -	95 €	103 €	145 €	225 €

Further custom-made configurations available at short notice!



Floor and wall penetrations

Floor Penetration Type BDF (p. 76) + Floor Penetration Type BDF - KG 2000 (p. 77) + Floor Penetration Type BDF - thermally insulated (p. 77) + Rodding Eye for **KRASO**® Type BDF (p. 77) + Universal Funnel (p. 78) + Wall Penetration Type B (p. 82) + Wall Penetration Type B - KG 2000 (p. 83) + Wall Penetration Type B - thermally insulated - (p. 83) + Wall Penetration Type SML (p. 83) + Wall Penetration Type FR (p. 84) + Wall Penetration Type FR - KG 2000 (p. 84) + Wall Penetration Type Universal (p. 85) + Wall Penetration Type Universal - KG 2000 (p. 85) + NBR seal (p. 85) + Wall Penetration Type B/SF 5 (p. 86) + Wall Penetration Type B/SF 5 - KG 2000 (p. 86) + Wall Penetration Type DFW (p. 87) + Wall Penetration Type DFW - KG 2000 (p. 87) + Slip-on Sleeve (p. 93) + Slip-on Sleeve - KG 2000 (p. 93) + 15° | 30° | 45° Bend (p. 93) + 15° | 30° | 45° Bend - KG 2000 (p. 93) + DWS - System (p. 94) + DWS - Accessories (p. 94) + Flange Pipe Type KG (p. 105) + Flange Pipe Type KG 2000 (p. 105) + Type KMB (p. 106) + Type KMB - KG 2000 (p. 106) + Type ÜSF - slip-on flange (p. 106)

Drains

Floor Drain (p. 96) + Floor Drain - KG 2000 (p. 96) + Floor Drain - thermally insulated - (p. 97) + Floor Drain Type FS - frost proof (p. 97) + Floor Drain Type FS - KG 2000 - frost proof (p. 98) + Floor Drain - Accessories (p. 98) + Floor Drain Type FS - RS - frost proof - backwater safe (p. 99) + Basement Drain (p. 100) + Basement Drain - KG 2000 (p. 101) + Drains - Accessories (p. 101) + Yard/Parking Level Drain (p. 102) + Type LES (p. 103)

Casings

Casing Type DFW/FE (p. 88) + Casing Type FE/SF 5 (p. 88) + Casing E/FE/KF (p. 89) + Casing K/FE/KF (p. 89) + Casing Type FE (p. 90) + Casing Type FE/MI (p. 90) + Fibre Cement Casing (p. 91) + Casing Type E/FE (p. 92) + VA - tubular sleeve (p. 92) + Casing Type E/FE/M (p. 92) + Flange Pipe Type FE (p. 105)

Wall Collar

Wall Collar (p. 79) + Wall Collar Universal (p. 80) + Wall Collar Lightning Protection Duo (p. 81)



KRASO® Floor Penetration Type BDF
Check the installation video
(just scan the QR code!)

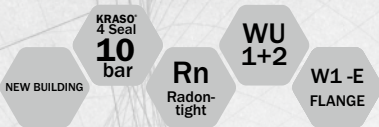

KRASO® Floor Penetration Type BDF

Simple, tight and approved

- + **KRASO®** 4 Seal – MPA-tested up to 10 bar!
- + IAF-tested: Radon-tight!
- + Made of dimensionally stable and pressure-resistant solid wall material: low abrasion, easy installation at low temperatures
- + In accordance with DIN EN 1401 (KG) or DIN EN 14758 (KG 2000)
- + Also available in KG 2000: polypropylene (PP), mineral-filled, smooth walls, long-lasting
- + Also available with oil- and bitumen resistant **KRASO®** Foil Flange
- + Formed plug-in sleeve on one side for connection to KG/HT pipes
- + Including **KRASO®** Cover as building period protective cover
- + Also available as thermally insulated floor penetration!
- + DafStB waterproof concrete guideline: stress class 1 + 2, with foil flange DIN 18533 W1-E

KRASO® Floor Penetration Type BDF **LG 1**

in accordance with DIN EN 1401, for connection to KG/HT pipes, also available with **KRASO®** Foil Flange, oil- and bitumen resistant, surrounding approx. 15 cm. For the integration of the foil flange, we recommend our adhesive and sealant **KRASO®** PU 50 | DafStB waterproof concrete guideline: stress class 1 + 2, with foil flange DIN 18533 W1-E

Type / Item	KRASO® Type BDF • KRASO® Type BDF with foil flange							
	110	125	160	200	250	315	400	500
Diameter DN								
Delivery length (in cm)	50							
KRASO® Type BDF	39 €	42 €	51 €	67 €	132 €	203 €	256 €	395 €
KRASO® Type BDF with foil flange	74 €	80 €	87 €	118 €	187 €	256 €	414 €	563 €
KRASO® PU 50	22 €							

Scope of supply: KRASO® Type BDF or KRASO® Type BDF with foil flange, KRASO® Cover as building period protective cover

Further diameters and lengths from 50 cm available on request!

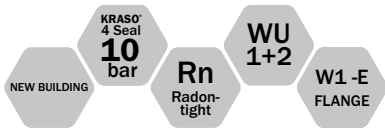

KRASO® Floor Penetration Type BDF - KG 2000 **LG 1**

in accordance with DIN EN 14758, for the connection to system KG 2000 lines, also available with **KRASO®** Foil Flange, oil- and bitumen resistant, surrounding approx. 15 cm. For the integration of the foil flange, we recommend our adhesive and sealant **KRASO®** PU 50 | **DafStB waterproof concrete guideline: stress class 1 + 2, with foil flange DIN 18533 W1-E**

Type / Item	KRASO® Type BDF - KG 2000 • KRASO® Type BDF - KG 2000 with foil flange							
Diameter DN	110	125	160	200	250	315	400	500
Delivery length (in cm)	50							
KRASO® Type BDF - KG 2000	50 €	56 €	74 €	107 €	255 €	343 €	448 €	612 €
KRASO® Type BDF - KG 2000 with foil flange	84 €	92 €	109 €	156 €	309 €	398 €	596 €	794 €
KRASO® PU 50	22 €							

Scope of supply: **KRASO®** Type BDF - KG 2000 or **KRASO®** Type BDF - KG 2000 with foil flange, **KRASO®** Cover as building period protective cover
Further diameters and lengths from 50 cm on request!

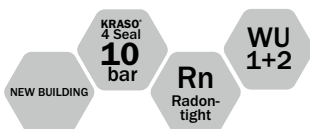

KRASO® Floor Penetration Type BDF - thermally insulated - **LG 1**

in accordance with DIN EN 14758, for connection to KG/HT pipes or KG 2000 lines, with thermally insulated body surrounding approx. 5 cm, **KRASO®** Cover as an installation aid | **DafStB waterproof concrete guideline: stress class 1 + 2**

Type / Item	KRASO® Type BDF - thermally insulated -							
Diameter DN	110	125	160	200	250	315	400	500
Delivery length (in cm)	50							
KRASO® Type BDF - thermally insulated -	189 €	201 €	224 €	307 €	492 €	616 €	711 €	833 €

Scope of supply: **KRASO®** Type BDF - thermally insulated -, **KRASO®** Cover as building period protective cover
Further diameters and lengths on request!



Rodding eye for **KRASO®** Type BDF **LG 1**

15 x 15 cm - screwable -



Diameter DN	110
Rodding eye for KRASO® Type BDF	292 €



KRASO® Universal Funnel
Check the installation video
(just scan the QR code!)

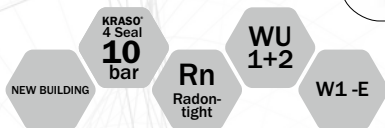

KRASO® Universal Funnel

The floor penetration for more flexibility

- + **KRASO® 4 Seal** - MPA-tested up to 10 bar!
- + IAF-tested: Radon-tight!
- + Break-resistant, KG 2000 system compatible
- + Displaced fall pipes can be corrected easily up to 45 degrees!
- + Integrated plug-in sleeve with Diameter DN 110 and **threefold reinforced lip ring**
- + **Surrounding connection/trowel flange** with textured surface
- + **Optionally available: screwable stainless steel flange for fixed-loose flange construction**
- + **Easy installation: ready-to-use, lugs, including walkable building period protective cover**
- + **DafStB waterproof concrete guideline: stress class 1 + 2, DIN 18533 W1-E**

KRASO® Universal Funnel **LG 1**

for the installation in waterproof concrete base plates for the connection of displaced KG/HT pipes and for the connection to KG/KG 2000 lines, with one-sided spigot, walkable building period protective cover. Optionally available: screwable **KRASO®** Stainless Steel Clamping Flange for the connection to non-adhesive foils | **DafStB waterproof concrete guideline: stress class 1 + 2**

Type / Item	KRASO® Universal Funnel
Line: Diameter DN	110
KRASO® Universal Funnel	53 €
KRASO® Stainless Steel Clamping Flange	70 €

Scope of supply: KRASO® Universal Funnel, walkable building period protective cover, additional protective cover
Optionally available: **KRASO®** Stainless Steel Clamping Flange

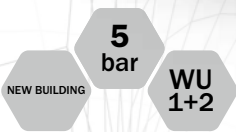

KRASO® Wall Collar

Fast, simple and tight

- + The fast, simple and tight solution for sealing pipes in waterproof concrete structures – base plate and wall!
- + Water pressure tight connection of pipelines: **MPA-tested up to 5 bar!**
- + **Radon-tight** – according to FHRK leaflet MB 101!
- + **Resistant to methane gas!**
- + For all smooth pipes in **DN 110, DN 125, DN 160 and DN 200!**
- + **Tool-free assembly** – simple and fast:
Simply pull the **KRASO® Wall Collar** over the pipe!
- + Including **KRASO® Cover** as building period protective cover!
- + **DafStB waterproof concrete guideline: stress class 1 + 2**



KRASO® Wall Collar **LG1**

for water pressure tight connection of pipelines with a smooth surface (KG, KG 2000, HT) in waterproof concrete structures: base plate and wall, MPA-tested up to 5 bar | **DafStB waterproof concrete guideline: stress class 1 + 2**

Type / Item	KRASO® Wall Collar			
Diameter pipeline	DN 110	DN 125	DN 160	DN 200
KRASO® Wall Collar	15 €	17 €	22 €	27 €

Scope of supply: KRASO® Wall Collar, KRASO® Cover as period protective cover
Further special designs available on request!

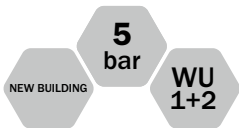

KRASO® Wall Collar Universal

Simple, tight, universally usable!

- + The fast, simple and tight solution for sealing pipes in waterproof concrete structures – base plate and wall!
- + **Stepless onion ring technology!** Scope of application 10 - 50 mm or 50 - 90 mm!
For all smooth cables and pipes!
- + Water pressure tight connection of pipelines: **MPA-tested up to 5 bar!**
- + **Radon-tight** – according to FHRK leaflet MB 101!
- + **Resistant to methane gas!**
- + With Torque Control Wrench **KRASO® DKS**: for safe and easy tightening of straps
- + **DafStB waterproof concrete guideline: stress class 1 + 2**

KRASO® Wall Collar Universal **LG 1**

Type / Item	KRASO® Wall Collar Universal 10 - 50	KRASO® Wall Collar Universal 50 - 90
Scope of application	10 - 50 mm	50 - 90 mm
KRASO® Wall Collar Universal	21 €	24 €

Scope of supply: KRASO® Wall Collar Universal with Torque Control Wrench **KRASO® DKS**, 2 stainless steel straps

Further special designs available on request!

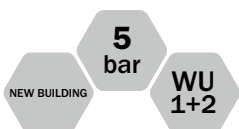

KRASO® Wall Collar

Simple and fast sealing!

- + The fast, simple and tight solution for sealing pipes in waterproof concrete structures – base plate and wall!
- + Water pressure tight connection of pipelines: **MPA-tested up to 5 bar!**
- + **Radon-tight** – according to FHRK leaflet MB 101!
- + **Resistant to methane gas!**
- + With Torque Control Wrench **KRASO® DKS**: for safe and easy tightening of straps
- + **DafStB waterproof concrete guideline: stress class 1 + 2**



KRASO® Wall Collar **LG 1**

Type / Item	KRASO® Wall Collar							
Diameter pipe	DN 25	DN 32	DN 40	DN 50	DN 63	DN 75	DN 80	DN 90
KRASO® Wall Collar	16 €	16 €	16 €	16 €	19 €	19 €	19 €	19 €

Scope of supply: KRASO® Wall Collar with Torque Control Wrench **KRASO® DKS**, 2 stainless steel straps

Further special designs available on request!

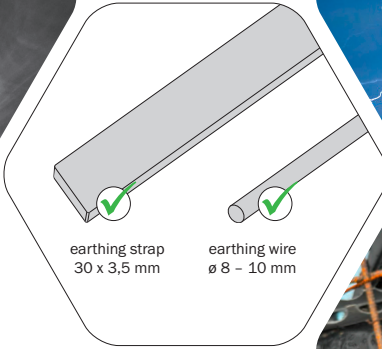
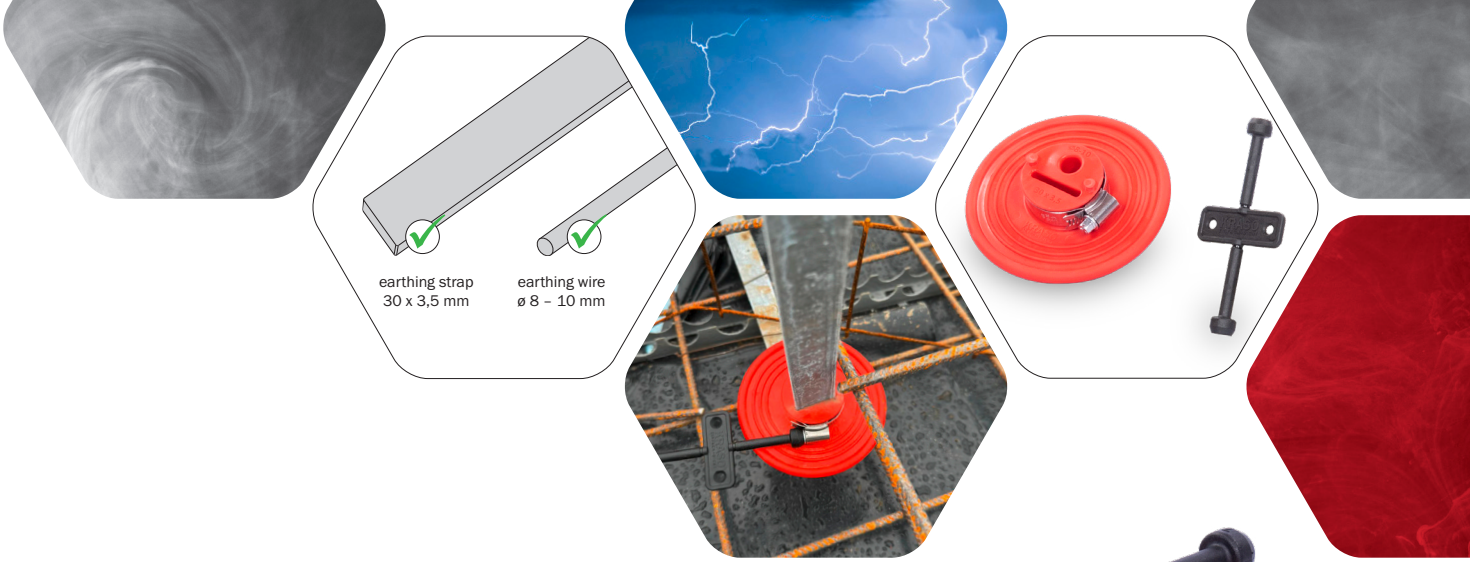

NEW BUILDING

5 bar

WU 1+2

KRASO® Wall Collar Lightning Protection Duo

Double the benefit, half the storage!

- + For the water pressure tight integration of earthing cables with factory-sealed openings: square earthing strap (30 x 3,5 mm) and earthing wire (ø 8 – 10 mm)
- + With Torque Control Wrench KRASO® DKS: for safe and easy tightening of straps
- + MPA-tested up to 5 bar!
- + Resistant to methane gas!
- + Radon-tight – according to FHRK leaflet MB 101!
- + DafStB waterproof concrete guideline: stress class 1 + 2

KRASO® Wall Collar Lightning Protection Duo **LG 1**

Type / Item	KRASO® Wall Collar Lightning Protection Duo
KRASO® Wall Collar Lightning Protection Duo	22 €

Scope of supply: KRASO® Wall Collar Lightning Protection Duo with Torque Control Wrench KRASO® DKS, 2 stainless steel straps
Further special designs available on request!



KRASO® Wall Penetration Type B
Check the installation video
(just scan the QR code!)

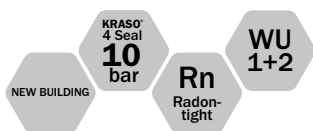

KRASO® Wall Penetration Type B

The proven wall penetration made of solid wall material

- + **KRASO® 4 Seal** – MPA-tested up to 10 bar!
- + IAF-tested: Radon-tight!
- + Dimensionally and pressure resistant solid wall material: low abrasion, easy installation at low temperatures
- + In accordance with **DIN EN 1401** (KG) or **DIN EN 14758** (KG 2000)
- + Also available in **KG 2000**: polypropylene (PP), mineral-filled, smooth walls, long-lasting
- + Formed plug-in-sleeve on both sides for connection to **KG/HT** pipes
- + Including two **KRASO®** Covers as an installation aid!
- + Also available as **thermally insulated wall penetration!**
- + **DafStB** waterproof concrete guideline: stress class **1 + 2**

KRASO® Wall Penetration Type B **LG 1**

in accordance with **DIN EN 1401**, for installation in waterproof concrete walls for connection to **KG/HT** pipes on both sides, with water pressure tight surrounding **KRASO® 4 Seal** | **DafStB** waterproof concrete guideline: stress class **1 + 2**

Type / Item	KRASO® Type B							
Diameter DN	110	125	160	200	250	315 ¹	400 ¹	500 ¹
Available standard wall thicknesses in cm	20 · 24 · 25 · 30 · 35 · 36,5 · 40 · 45 · 50							
KRASO® Type B	52 €	62 €	69 €	97 €	239 €	395 €	473 €	571 €
Surcharge: special dimensions up to 50 cm	21 €				34 €			

¹ Only usable as push-through sleeve, because the plug-in length is not suitable for double-sided usage according to **EN 1401-1**

Scope of supply: **KRASO®** Type B, 2 **KRASO®** Covers as an installation aid

Further diameters and wall thicknesses available on request!

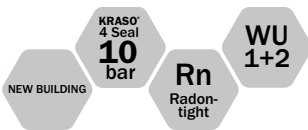

KRASO® Wall Penetration Type B - KG 2000 **LG 1**

in accordance with DIN EN 14758, for installation in waterproof concrete walls for connection to system KG 2000 pipes, with water pressure tight surrounding, thermally welded **KRASO®** 4 Seal, formed plug-in sleeve on both sides, 2 **KRASO®** Covers as an installation aid | **DafStB waterproof concrete guideline: stress class 1 + 2**

Type / Item	KRASO® Type B - KG 2000							
Diameter DN	110	125	160	200	250	315 ¹	400 ¹	500 ^{1,2}
Available standard wall thicknesses in cm	20 · 24 · 25 · 30 · 35 · 36,5 · 40 · 45 · 50							
KRASO® Type B - KG 2000	72 €	81 €	111 €	169 €	287 €	476 €	617 €	1.067 €
Surcharge: special dimensions up to 50 cm	21 €				34 €			

¹ Only usable as push-through sleeve because the plug-in length according to EN 1401-1 is not suitable for double-sided usage

² For product technical reasons wall thickness 20 cm with **KRASO®** 3 Seal

Scope of supply: **KRASO®** Type B - KG 2000, 2 **KRASO®** Covers as an installation aid

Further diameters and wall thicknesses available on request!

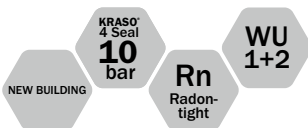

KRASO® Wall Penetration Type B - thermally insulated - **LG 1**

in accordance with DIN EN 14758, for installation in waterproof concrete walls, thermally welded **KRASO®** 4 Seal on both sides, formed plug-in sleeve on both sides, 2 **KRASO®** Covers as an installation aid and thermally insulated body surrounding approx. 5 cm | **DafStB waterproof concrete guideline: stress class 1 + 2**

Type / Item	KRASO® Type B - thermally insulated -							
Diameter DN	110	125	160	200	250	315 ¹	400 ¹	500 ¹
Available standard wall thicknesses in cm	20 · 24 · 25 · 30 · 35 · 36,5 · 40 · 45 · 50							
KRASO® Type B - thermally insulated -	249 €	275 €	302 €	352 €	533 €	799 €	925 €	1.646 €

¹ Only usable as push-through sleeve, because the plug-in length is not suitable for double-sided usage according to EN 1401-1

Scope of supply: **KRASO®** Type B - thermally insulated -, 2 **KRASO®** Covers as an installation aid

Further diameters and wall thicknesses available on request!



KRASO® Wall Penetration Type SML **LG 1**

grey iron waste water pipe according to DIN EN 877 for installation in waterproof concrete walls for connection to SML pipes on both sides, with water pressure tight surrounding **KRASO®** 4 Seal and styrofoam recess core on both sides | **DafStB waterproof concrete guideline: stress class 1 + 2**

Type / Item	KRASO® Type SML				
Diameter DN	110	125	160	200	250
Available standard wall thicknesses in cm	24 · 25 · 30				
KRASO® Type SML	84 €	100 €	126 €	227 €	332 €
Surcharge: per every or partial 10 cm	12 €	13 €	16 €	38 €	44 €

Scope of supply: **KRASO®** Type SML incl. 2 styrofoam recess cores at the sides

Further diameters and wall thicknesses available on request! Also available in TML and KML for an additional charge!



KRASO® Wall Penetration Type FR
Check the installation video
(just scan the QR code!)



KRASO® Wall Penetration Type FR

Always the right flow direction

- + One flow direction!
- + Flexible yet water tight connection to the pipe system: stresses caused by settling of KG pipes are minimised!
- + **KRASO® 4 Seal** – MPA-tested up to 10 bar!
- + IAF-tested: Radon-tight!
- + Dimensionally and pressure resistant solid wall material: low abrasion, easy installation at low temperatures
- + In accordance with DIN EN 1401 (KG) or DIN EN 14758 (KG 2000)
- + Also available in KG 2000: polypropylene (PP), mineral-filled, smooth walls, long-lasting
- + DafStB waterproof concrete guideline: stress class 1 + 2



cross section

KRASO® Wall Penetration Type FR - flow direction **LG1**

in accordance with DIN EN 1401, for installation in waterproof concrete walls, for connection to KG/HT pipes on both sides | DafStB waterproof concrete guideline: stress class 1 + 2

Type / Item	KRASO® Type FR		
Diameter DN	110	125	160
Available standard wall thicknesses in cm	20 ¹ · 24 · 25 · 30		
KRASO® Type FR	55 €	64 €	73 €

¹ 20 cm wall thickness: only DN 110 available

Scope of supply: KRASO® Type FR, 2 KRASO® Covers as an installation aid

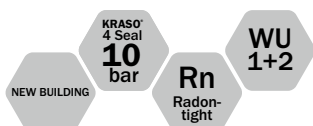

KRASO® Wall Penetration Type FR - KG 2000 **LG1**

in accordance with DIN EN 14758, for installation in waterproof concrete walls for connection to KG 2000 pipes on both sides, with water pressure tight surrounding, thermally welded KRASO® 4 Seal, formed plug-in sleeve on one side, one-sided spigot and 2 KRASO® Covers as an installation aid | DafStB waterproof concrete guideline: stress class 1 + 2

Type / Item	KRASO® Type FR - KG 2000		
Diameter DN	110	125	160
Available standard wall thicknesses in cm	24 · 25 · 30		
KRASO® Type FR - KG 2000	72 €	81 €	111 €

Scope of supply: KRASO® Type FR - KG 2000, 2 KRASO® Covers as an installation aid

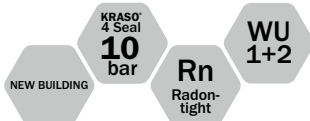

KRASO® Wall Penetration Type Universal **LG 1**

in accordance with DIN EN 1401, for installation in waterproof concrete walls, for connection to KG/HT pipes on both sides (**Uni B**) or for pipes to be pushed through (**Uni D**), with water pressure tight surrounding **KRASO® 4 Seal**, with markings for a simple shortening on-site to standard wall thicknesses | **DafStB waterproof concrete guideline: stress class 1 + 2**

Type / Item	KRASO® Type Universal B • KRASO® Type Universal D		
Diameter DN	110	125	160
for wall thicknesses from ... to ... (in cm)	12 - 30	12 - 30	17,5 - 36,5
KRASO® Type Universal B	52 €	62 €	69 €
KRASO® Type Universal D			

Scope of supply: **KRASO® Type Universal B** with formed plug-in sleeve on both sides, 2 **KRASO® Covers** as an installation aid • **KRASO® Type Universal D** with integrated push-through sleeve, 2 **KRASO® Covers** as an installation aid

Further diameters and wall thicknesses available on request!

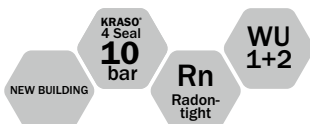

KRASO® Wall Penetration Type Universal - KG 2000 **LG 1**

in accordance with DIN EN 14758, for installation in waterproof concrete walls, for connection to KG 2000 pipes on both sides (**Uni B - KG 2000**) or for pipes to be pushed through (**Uni D - KG 2000**), with water pressure tight surrounding, thermally welded **KRASO® 4 Seal**, with markings for a simple shortening on-site to standard wall thicknesses | **DafStB waterproof concrete guideline: stress class 1 + 2**

Type / Item	KRASO® Type Universal B - KG 2000 • KRASO® Type Universal D - KG 2000		
Diameter DN	110	125	160
for wall thicknesses from ... to ... (in cm)	15 - 30	17,5 - 30	20 - 36,5
KRASO® Type Universal B - KG 2000	88 €	104 €	138 €
KRASO® Type Universal D - KG 2000			

Scope of supply: **KRASO® Type Universal B - KG 2000** with formed plug-in sleeve on both sides, 2 **KRASO® Covers** as an installation aid • **KRASO® Type Universal D - KG 2000** with integrated push-through sleeve, 2 **KRASO® Covers** as an installation aid

Further diameters and wall thicknesses in KG 2000 available on request!



NBR seal **LG 1**

oil-resistant lip seal ring for system KG and KG 2000

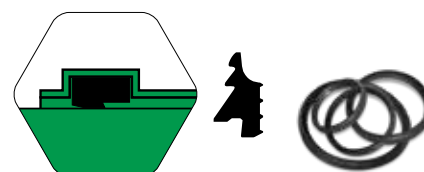

Type / Item	NBR seal							
Diameter DN	110	125	160	200	250	315	400	500
NBR seal KG	1,85 €	2,50 €	3,20 €	5,10 €	12,10 €	16,70 €	31 €	79 €
NBR seal KG 2000	5,35 €	12 €	24 €	37 €	79 €	130 €	155 €	195 €

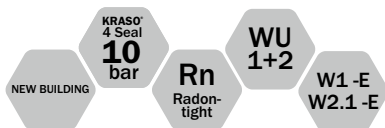

KRASO® Wall Penetration Type B/SF 5

Secure connection to bitumen and reactive sealings

- + Dimensionally stable and pressure-resistant solid wall material: low abrasion, installation even at lower temperatures
- + Pipe and pipe material in accordance with DIN EN 1401 (KG) or DIN EN 14758 (KG 2000)
- + **KRASO® 4 Seal** – MPA-tested up to 10 bar!
- + IAF-tested: Radon-tight!
- + Surrounding approx. 5 cm trowel flange for secure connection of bitumen thick coating such as KMB or reactive sealings: roughened or tissue coated
- + Also available: trowel flange made of PP with dovetail groove as **KRASO® Type B/SF 5 - KG 2000** for the secure gripping of bitumen thick coating
- + **DafStB waterproof concrete guideline: stress class 1 + 2, DIN 18533 W1 -E and W2.1 -E**

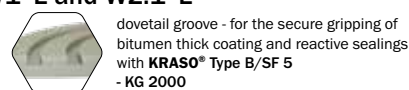
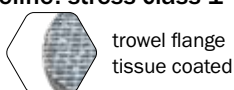
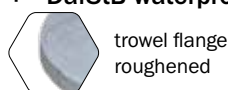

KRASO® Wall Penetration Type B/SF 5 **LG 1**

for installation in waterproof concrete walls for connection to KG/HT pipes on both sides, with trowel flange on one side, roughened (**KRASO® Type B/SF 5 - R**) or tissue coated (**KRASO® Type B/SF 5 - G**) for the secure connection of bitumen thick coating (e.g. KMB) and reactive sealings, surrounding approx. 5 cm, formed plug-in sleeve on both sides, 2 **KRASO® Covers** as an installation aid | **DafStB waterproof concrete guideline: stress class 1 + 2, DIN 18533 W1 -E and W2.1 -E**

Type / Item	KRASO® Type B/SF 5					
Diameter DN	110	125	160	200	250	315
Available standard wall thicknesses in cm	20 · 24 · 25 · 30 · 35 · 36,5 · 40 · 45 · 50					
KRASO® Type B/SF 5 - R	78 €	94 €	107 €	137 €	306 €	488 €
KRASO® Type B/SF 5 - G	86 €	98 €	111 €	143 €	311 €	497 €

Scope of supply: **KRASO® Type B/SF 5 - R** with trowel flange on one side SF/5, roughened, 2 **KRASO® Covers** as an installation aid • **KRASO® Type B/SF 5 - G** with trowel flange on one side SF/5, tissue coated, 2 **KRASO® Covers** as an installation aid

Further diameters and wall thicknesses available on request!

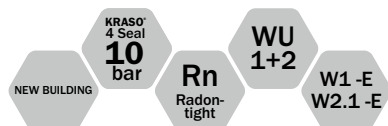

KRASO® Wall Penetration Type B/SF 5 - KG 2000 **LG 1**

for installation in waterproof concrete walls for the connection to KG 2000 pipes on both sides, with trowel flange on one side with dovetail groove for the secure connection of bitumen thick coating and reactive sealings, formed plug-in sleeve on both sides, 2 **KRASO® Covers** as an installation aid | **DafStB waterproof concrete guideline: stress class 1 + 2, DIN 18533 W1 -E and W2.1 -E**

Type / Item	KRASO® Type B/SF 5 - KG 2000					
Diameter DN	110	125	160	200	250	315
Available standard wall thicknesses in cm	20 · 24 · 25 · 30 · 35 · 36,5 · 40 · 45 · 50					
KRASO® Type B/SF 5 - KG 2000	146 €	162 €	186 €	246 €	499 €	747 €

Scope of supply: **KRASO® Type B/SF 5 - KG 2000**, 2 **KRASO® Covers** as an installation aid

Further diameters and wall thicknesses available on request!



KRASO® Wall Penetration Type DFW

Easy and secure sealing in precast walls

- + For the installation in triple wall elements: **stop occurring water at the outer shell!**
- + **KRASO® Type DFW 4: KRASO® 2 Seal on both sides – MPA-tested up to 3.5 bar!**
- + **KRASO® Type DFW 6: KRASO® 2 Seal on one side, central KRASO® 4 Seal – MPA-tested up to 10 bar!**
- + **KRASO® Type DFW 8: KRASO® 2 Seal on both sides, central KRASO® 4 Seal – MPA-tested up to 10 bar!**
- + **IAF-tested: Radon-tight!**
- + Pipe and pipe-material in accordance with DIN EN 1401 (KG) or DIN EN 14758 (KG 2000)
- + DafStB waterproof concrete guideline: stress class 1 + 2

KRASO® Wall Penetration Type DFW - triple wall - especially for precast elements **LG 1**

in accordance with DIN EN 1401, for the installation in triple walls, for connection to KG/HT pipes on both sides, with formed plug-in sleeve on both sides, 2 KRASO® Covers as an installation aid | DafStB waterproof concrete guideline: stress class 1 + 2

Type / Item	KRASO® Type DFW					
Diameter DN	110	125	160	200	250	315 ¹
Available standard wall thicknesses in cm	20 · 24 · 25 · 30 · 35 · 36,5 · 40 · 45 · 50					
KRASO® Type DFW 4	67 €	78 €	88 €	118 €	295 €	487 €
KRASO® Type DFW 6	73 €	82 €	93 €	130 €	327 €	539 €
KRASO® Type DFW 8	93 €	107 €	122 €	160 €	409 €	672 €
Surcharge: special dimensions up to 50 cm	21 €				34 €	

¹ Only usable as push-through sleeve because the plug-in length according to EN 1401-1 is not suitable for double-sided usage

Scope of supply: KRASO® Type DFW 4, KRASO® Type DFW 6 or KRASO® Type DFW 8, 2 KRASO® Covers as an installation aid

Further diameters and wall thicknesses available on request!



KRASO® Wall Penetration Type DFW - KG 2000 - triple wall - especially for precast elements **LG 1**

in accordance with DIN EN 14758, for the installation in triple walls, for the connection to KG 2000 pipes on both sides, with formed plug-in sleeve on both sides, 2 KRASO® Covers as an installation aid | DafStB waterproof concrete guideline: stress class 1 + 2

Type / Item	KRASO® Type DFW - KG 2000					
Diameter DN	110	125	160	200	250	315 ^{1,2}
Available standard wall thicknesses in cm	20 · 24 · 25 · 30 · 35 · 36,5 · 40 · 45 · 50					
KRASO® Type DFW 4 - KG 2000	95 €	104 €	147 €	216 €	368 €	609 €
KRASO® Type DFW 6 - KG 2000	104 €	116 €	161 €	239 €	409 €	673 €
KRASO® Type DFW 8 - KG 2000	130 €	144 €	202 €	298 €	509 €	841 €
Surcharge: special dimensions up to 50 cm	21 €				34 €	

¹ Only usable as push-through sleeve because the plug-in length according to EN 1401-1 is not suitable for double-sided usage

² For product-technical reasons wall thickness 20 cm with KRASO® 3 Seal

Scope of supply: KRASO® Type DFW 4 - KG 2000, KRASO® Type DFW 6 - KG 2000 or KRASO® Type DFW 8 - KG 2000, 2 KRASO® Covers as an installation aid

Further diameters and wall thicknesses available on request!

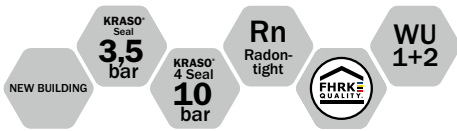

KRASO® Casing Type DFW/FE - triple wall - especially for precast elements - **LG 1**

for the installation into triple walls, thick-walled plastic casing true diameter for concreting, as a recess for retrofit installation of cables or pipes using a sealing insert (not included in the scope of supply), with water pressure tight surrounding **KRASO® 2 Seal** on both sides (**KRASO® Type DFW/FE 4**), **KRASO® 2 Seal** on one side and water pressure tight surrounding **KRASO® 4 Seal** in the middle (**KRASO® Type DFW/FE 6**), **KRASO® 2 Seal** on both sides and central water pressure tight surrounding **KRASO® 4 Seal** (**KRASO® Type DFW/FE 8**), 2 **KRASO® Covers** as an installation aid, ID = InternalDiameter true diameter casing | **DafStB waterproof concrete guideline: stress class 1 + 2**

Type / Item	KRASO® Type DFW/FE					
InternalDiameter ID	100	125	150	200	250	300
Available standard wall thicknesses in cm	20 · 24 · 25 · 30 · 35 · 36,5 · 40 · 45 · 50					
KRASO® Type DFW/FE 4	44 €	48 €	53 €	79 €	89 €	95 €
KRASO® Type DFW/FE 6	49 €	53 €	60 €	86 €	101 €	107 €
KRASO® Type DFW/FE 8	62 €	66 €	73 €	109 €	125 €	130 €

Scope of supply: **KRASO® Type DFW/FE 4**, **KRASO® Type DFW/FE 6** or **KRASO® Type DFW/FE 8**, 2 **KRASO® Covers** as an installation aid

Further diameters and wall thicknesses available on request!

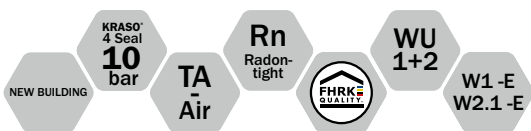

KRASO® Casing Type FE/SF 5

Thick-walled plastic casing - true diameter. Secure connection of bitumen thick coating/reactive sealings

- + Thick-walled true diameter plastic casing for concreting
- + As a recess for retrofit installation of cables or pipes using a sealing insert
- + Approx. 5 cm surrounding trowel flange on one side for a secure connection of bitumen thick coating and reactive sealings: roughened or tissue coated
- + **KRASO® 4 Seal** – MPA-tested up to 10 bar! IAF tested: Radon-tight! Gas- and odour-tight – high-quality in terms of TA-Air!
- + Tested in accordance with FHRK test specification GE 102!
- + Also available: **KRASO® Casing Type FE/SF 5 KG 2000** with trowel flange made of PP with dovetail groove for the secure connection of bitumen thick coating and reactive sealings
- + **DafStB waterproof concrete guideline: stress class 1 + 2, DIN 18533 W1 -E and W2.1 -E**



trowel flange roughened



trowel flange tissue coated



dovetail groove - for the secure connection of bitumen thick coating and reactive sealings **KRASO® Casing Type FE/SF 5 - KG 2000**

KRASO® Casing Type FE/SF 5 **LG 1**

for concreting, with trowel flange on one side, roughened (**KRASO® Type FE/SF 5 - R**) or tissue coated (**KRASO® Type FE/SF 5 - G**), surrounding approx. 5 cm, 2 **KRASO® Covers** as an installation aid, ID = InternalDiameter true diameter casing | **DafStB waterproof concrete guideline: stress class 1 + 2, DIN 18533 W1 -E and W2.1 -E**

Type / Item	KRASO® Type FE/SF 5					
InternalDiameter ID	100	125	150	200	250	300
Available standard wall thicknesses in cm	20 · 24 · 25 · 30 · 35 · 36,5 · 40 · 45 · 50					
KRASO® Type FE/SF 5 - R	64 €	70 €	78 €	107 €	124 €	138 €
KRASO® Type FE/SF 5 - G	68 €	77 €	83 €	111 €	128 €	143 €

Scope of supply: **KRASO® Type FE/SF 5 - R** with trowel flange on one side SF/5, roughened, 2 **KRASO® Covers** as an installation aid • **KRASO® Type FE/SF 5 - G** with trowel flange on one side SF/5, tissue coated, 2 **KRASO® Covers** as an installation aid

Further diameters and wall thicknesses available on request!



KRASO® Casings with bonding flange

Simple integration into the sealing of larger areas

- + True diameter casing with surrounding bonding flange according to DIN 18533 for a simple and fast integration into the sealing of larger areas („black tank“).
- + As a recess for the retrofit installation of cables or pipes using a sealing insert!
- + Available in non-corrosive stainless steel or with thick-walled true diameter plastic casing
- + DIN 18533 W1 -E and W2.1 -E



KRASO® Casing E/FE/KF **LG 1**

stainless steel/true diameter casing/ bonding flange

stainless steel true diameter casing with stainless steel bonding flange, surrounding approx. 12 cm, according to DIN 18533, for concreting, made of non-corrosive stainless steel V2A, for the installation of cables or pipes using a sealing insert (not included in the scope of supply), with 2 KRASO® Covers as an installation aid. ID = InternalDiameter true diameter casing | DIN 18533 W1 -E and W2.1 -E

Type / Item	KRASO® Casing E/FE/KF						
InternalDiameter ID	80	100	125	150	200	250	300
Available standard wall thicknesses in cm	20 • 24 • 25 • 30						
Diameter bonding flange	surrounding 120 mm						
KRASO® Casing E/FE/KF	153 €	198 €	218 €	251 €	288 €	386 €	454 €
Surcharge: per each additional 10 cm	22 €	28 €	32 €	36 €	42 €	55 €	64 €

Scope of supply: KRASO® Casing E/FE/KF, 2 KRASO® Covers as an installation aid

Further diameters and wall thicknesses available on request! Also available in V4A at an additional charge!



KRASO® Casing K/FE/KF - electrogalvanised **LG 1**

- plastic/true diameter casing/bonding flange

thick-walled true diameter plastic casing with electrogalvanised bonding flange, surrounding approx. 12 cm, according to DIN 18533, for concreting, for the installation of cables or pipes using a sealing insert (not included in the scope of supply), 2 KRASO® Covers as an installation aid ID = InternalDiameter true diameter casing | DIN 18533 W1 -E and W2.1 -E

Type / Item	KRASO® Casing K/FE/KF - electrogalvanised						
InternalDiameter ID	80	100	125	150	200	250	300
Available standard wall thicknesses in cm	20 • 24 • 25 • 30						
Diameter bonding flange	surrounding 120 mm						
KRASO® Casing K/FE/KF - electrogalvanised -	115 €	148 €	164 €	189 €	216 €	290 €	345 €
Surcharge: per each additional 10 cm	1,30 €	1,40 €	2,10 €	2,30 €	4,70 €	8,20 €	14,10 €

Scope of supply: KRASO® Casing K/FE/KF - electrogalvanised, 2 KRASO® Covers as an installation aid

Further diameters and wall thicknesses available on request!



KRASO® Casing Type FE
Check the installation video
(just scan the QR code!)

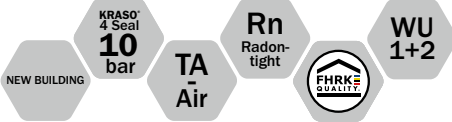

KRASO® Casing Type FE/MI
with fixed claw

KRASO® Casing Type FE and FE/MI

These casings convince!

- + Thick-walled true diameter plastic casing for concreting
- + **KRASO® 4 Seal** – MPA-tested up to 10 bar!
Gas- and odour-tight – high-quality in terms of TA-Air!
- + IAF-tested: Radon-tight!
- + Tested in accordance with FHRK test specification GE 102!
- + **Material and processing: weatherproof, impact-resistant plastic, KRASO® 4 Seal** joined monolithically to the plastic pipe by vulcanization
- + **Every diameter and every wall thickness available at short notice!**
If necessary, the size can be adapted individually on the construction-site!
- + Low weight: easy handling, simple installation, low transport costs!
- + Including installation covers! No pre-treatment required!
- + DafStB waterproof concrete guideline: stress class 1 + 2

KRASO® Casing Type FE - true diameter casing • KRASO® Casing Type FE/MI - true diameter casing with inner core **LG 1**

recess for retrofit installation of cables or pipes using a sealing insert (not included in the scope of supply) • plastic - true diameter casing with reinforced inner core, with eyelets, shear key and enclosed fixed claw as an installation aid, ID = InternalDiameter true diameter casing | DafStB waterproof concrete guideline: stress class 1 + 2

Type / Item	KRASO® Casing Type FE							KRASO® Casing Type FE/MI								
InternalDiameter in mm	80	100	125	150	200	250	300	350	400	450	500	600	700	800	900	1000
Available standard wall thicknesses in cm	20 · 24 · 25 · 30 · 35 · 36,5 · 40 · 45 · 50															
	40 €	41 €	43 €	47 €	69 €	80 €	86 €	231 €	253 €	272 €	288 €	445 €	589 €	694 €	877 €	927 €
Available standard wall thicknesses in cm	60 · 70 · 80 · 90 · 100															
	55 €	56 €	63 €	67 €	94 €	125 €	157 €	271 €	309 €	344 €	364 €	529 €	709 €	846 €	1.081 €	1.167 €

Scope of supply: KRASO® Casing Type FE, 2 KRASO® Covers as an installation aid • KRASO® Casing Type FE/MI, fixed claw as an installation aid
Further diameters and wall thicknesses available on request!

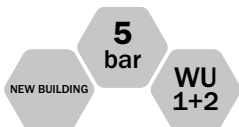

KRASO® Fibre Cement Casing

Water pressure tight penetration with homogeneous connection to the concrete

- + Casing made of fibre cement as a **recess in waterproof concrete walls** („white tank“)
- + For concreting: the surrounding external profile ensures a **homogeneous and water pressure tight connection** to the concrete
- + **MPA-tested up to 5 bar!**
- + **Radon-tight** – according to FHRK leaflet MB 101
- + Corresponds to the expansion range (“expansion coefficient“) of waterproof concrete
- + Optionally available: **KRASO® Installation/Formwork aid**
- + **Fire protection class A1** according to DIN EN 13501-1
- + **DafStB waterproof concrete guideline: stress class 1 + 2**

KRASO® Installation/Formwork aid



for DN 80 to DN 200



for DN 250 to DN 800

KRASO® Fibre Cement Casing **LG 6**

fibre cement casing for the installation in waterproof concrete walls for installation of pipes or cables using a sealing inserts (not included in the scope of supply) | **DafStB waterproof concrete guideline: stress class 1 + 2**

Type / Item	KRASO® Fibre Cement Casing														
Internal Diameter in mm	80	100	125	150	200	250	300	350	400	450	500	600	700	800	
Available standard wall thicknesses in cm															
20	37 €	39 €	45 €	50 €	60 €	78 €	82 €	100 €	138 €	157 €	187 €	213 €	284 €	327 €	
24	43 €	45 €	52 €	56 €	69 €	91 €	97 €	117 €	162 €	185 €	219 €	250 €	337 €	388 €	
25	44 €	46 €	54 €	58 €	71 €	93 €	99 €	122 €	168 €	192 €	227 €	259 €	350 €	403 €	
30	50 €	52 €	58 €	63 €	76 €	97 €	117 €	144 €	199 €	227 €	269 €	306 €	416 €	480 €	
35	57 €	59 €	66 €	71 €	86 €	106 €	130 €	166 €	229 €	262 €	310 €	352 €	482 €	556 €	
36,5	62 €	65 €	76 €	82 €	93 €	112 €	140 €	173 €	238 €	272 €	322 €	366 €	502 €	579 €	
40	64 €	67 €	79 €	86 €	95 €	117 €	145 €	189 €	259 €	296 €	350 €	398 €	548 €	633 €	
50	74 €	78 €	93 €	104 €	104 €	121 €	160 €	233 €	320 €	366 €	433 €	491 €	649 €	786 €	
60	83 €	86 €	102 €	112 €	121 €	143 €	177 €	277 €	381 €	436 €	515 €	584 €	811 €	939 €	
80	103 €	108 €	131 €	147 €	151 €	173 €	199 €	352 €	484 €	549 €	654 €	742 €	1.075 €	1.245 €	
100	124 €	130 €	172 €	194 €	203 €	246 €	311 €	440 €	605 €	692 €	817 €	927 €	1.338 €	1.551 €	
120	149 €	156 €	206 €	233 €	244 €	295 €	373 €	528 €	726 €	830 €	980 €	1.112 €	1.606 €	1.861 €	
optional: KRASO® Installation/Formwork aid	4,10 €	4,90 €	6,10 €	7,50 €	9,80 €	15,70 €	19,40 €	26,20 €	33,40 €	42,30 €	52,60 €	75,80 €	102,40 €	133,80 €	

Further diameters and wall thicknesses available on request!

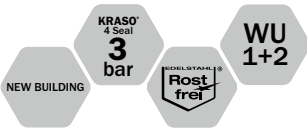

KRASO® Casing Type E/FE - stainless steel/true diameter casing **LG 1**

stainless steel casing for concreting, as a recess for retrofit installation of pipes and cables using a sealing insert (not included in the scope of supply), made of non-corrosive stainless steel V2A, with water pressure tight and gas- and odour-tight, surrounding **KRASO®** 4 Seal and 2 **KRASO®** Covers as an installation aid, ID = InternalDiameter true diameter casing | **DafStB waterproof concrete guideline: stress class 1 + 2**

Type / Item	KRASO® Type E/FE						
InternalDiameter ID	80	100	125	150	200	250	300
Available standard wall thicknesses in cm	20 • 24 • 25 • 30						
KRASO® Type E/FE	146 €	189 €	208 €	240 €	274 €	367 €	437 €
Surcharge: per each additional 10 cm	23 €	28 €	32 €	37 €	42 €	56 €	64 €

Scope of supply: KRASO® Casing Type E/FE, 2 KRASO® Covers as an installation aid

Further diameters and wall thicknesses available on request! Also available in V4A at an additional charge!



VA - tubular sleeve **LG 1**

stainless steel tubular sleeve for concreting, as non-water pressure tight recess for retrofit installation of pipes and cables using sealing insert (not included in the scope of supply), made of non-corrosive stainless steel V2A, ID = InternalDiameter true diameter

Type / Item	VA - tubular sleeve						
InternalDiameter ID	80	100	125	150	200	250	300
Available standard wall thicknesses in cm	20 • 24 • 25 • 30						
VA - tubular sleeve	61 €	78 €	88 €	99 €	114 €	151 €	180 €
Surcharge: per each additional 10 cm	23 €	28 €	32 €	37 €	42 €	56 €	64 €

Scope of supply: VA - tubular sleeve made of non-corrosive stainless steel V2A with 2 KRASO® Covers as an installation aid

Further diameters and wall thicknesses available on request! Also available in V4A at an additional charge!

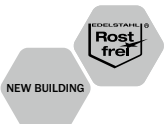

KRASO® Casing Type E/FE/M - stainless steel/true diameter casing/middle flange **LG 1**

stainless steel casing for concreting with middle flange, surrounding approx. 10 cm, as a recess for retrofit installation of pipes and cables using a sealing insert (not included in the scope of supply), made of non-corrosive stainless steel V2A, ID = InternalDiameter true diameter casing

Type / Item	KRASO® Type E/FE/M						
InternalDiameter ID	80	100	125	150	200	250	300
Available standard wall thicknesses in cm	20 • 24 • 25 • 30						
KRASO® Type E/FE/M	191 €	244 €	272 €	312 €	357 €	478 €	564 €
Surcharge: per each additional 10 cm	23 €	28 €	32 €	37 €	42 €	56 €	64 €

Scope of supply: KRASO® Casing Type E/FE/M, 2 KRASO® Covers as an installation aid

Further diameters and wall thicknesses available on request! Also available in V4A at an additional charge!

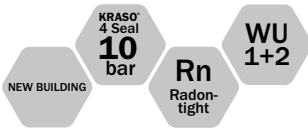

KRASO® Slip-on Sleeve **LG 1**

in accordance with DIN EN 1401, for installation in waterproof concrete walls for KG/HT pipes to be pushed through, with water pressure tight surrounding **KRASO® 4 Seal** | **DafStB waterproof concrete guideline: stress class 1 + 2**

Type / Item	KRASO® Slip-on Sleeve							
Diameter DN	110	125	160	200	250	315	400	500
KRASO® Slip-on Sleeve	40 €	46 €	53 €	67 €	142 €	215 €	306 €	573 €

Also available as double sleeve with internal stop on request!

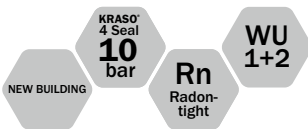

KRASO® Slip-on Sleeve - KG 2000 **LG 1**

in accordance with DIN EN 14758, for installation in waterproof concrete walls for KG 2000 pipes to be pushed through, with water pressure tight surrounding, thermally welded **KRASO® 4 Seal** | **DafStB waterproof concrete guideline: stress class 1 + 2**

Type / Item	KRASO® Slip-on Sleeve - KG 2000							
Diameter DN	110	125	160	200	250	315	400	500
KRASO® Slip-on Sleeve - KG 2000	52 €	60 €	78 €	129 €	209 €	269 €	365 €	691 €

Also available as double sleeve with internal stop on request!

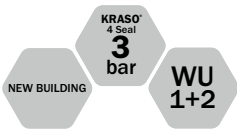

KRASO® 15° | 30° | 45° Bend **LG 1**

in accordance with DIN EN 1401, for installation in waterproof concrete walls for the connection to KG/HT pipes, with water pressure tight surrounding **KRASO® 4 Seal** and formed plug-in sleeve on one side | **DafStB waterproof concrete guideline: stress class 1 + 2**

Type / Item	KRASO® 15° 30° 45° Bend							
Diameter DN	110 ¹	125 ¹	160 ¹	200 ¹	250	315	400	500
KRASO® 15° 30° 45° Bend	29 €	34 €	39 €	73 €	124 €	192 €	330 €	721 €

¹ for technical production reasons partly **KRASO® 3 Seal**

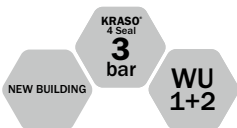

KRASO® 15° | 30° | 45° Bend - KG 2000 **LG 1**

in accordance with DIN EN 14758, for installation in waterproof concrete walls for the connection to KG 2000 pipes, with water pressure tight surrounding, thermally welded **KRASO® 4 Seal** and formed plug-in sleeve on one side | **DafStB waterproof concrete guideline: stress class 1 + 2**

Type / Item	KRASO® 15° 30° 45° Bend - KG 2000							
Diameter DN	110 ¹	125 ¹	160 ¹	200 ¹	250	315 ²	400 ²	500
KRASO® 15° 30° 45° Bend - KG 2000	44 €	55 €	75 €	111 €	255 €	409 €	589 €	1.148 €

¹ for technical production reasons partly **KRASO® 3 Seal**

² not available as 30° bend



KRASO® Tie Point DWS - System
Check the installation video
(just scan the QR code!)

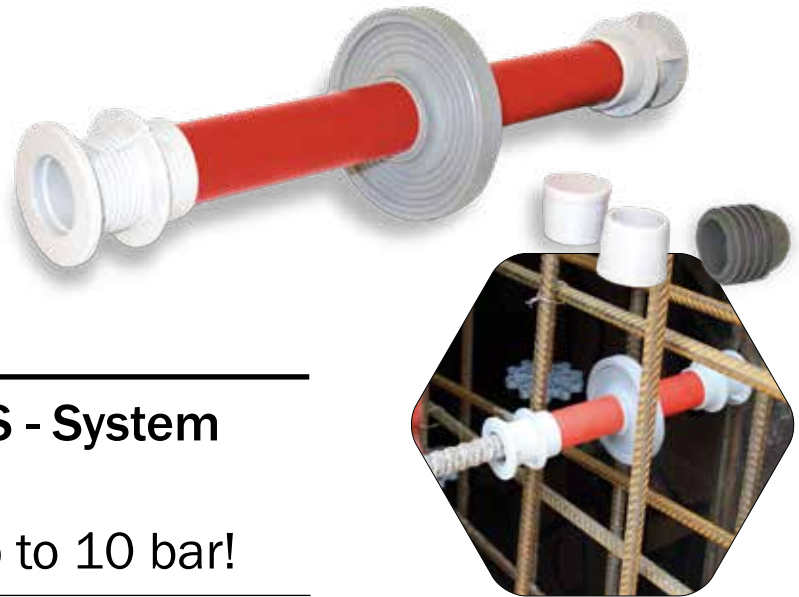

NEW BUILDING

10 bar

F 180
Fireproof

WU 1+2

KRASO® Tie Point DWS - System

Simple and quick use,
water pressure tight up to 10 bar!

- + Water pressure tight tie point as spacer for the formwork of waterproof concrete walls.
- + Delivery ready-to-use according to wall thickness - no assembly necessary on the construction-site!
- + Simple installation - no time-consuming adhesion of blanking plugs and expensive reworking!
- + 10 bar water pressure tightness internally and externally due to vulcanised locking disc and sealing and blanking plugs for simple locking
- + Fireproof according to F 180!
- + DafStB waterproof concrete guideline: stress class 1 + 2

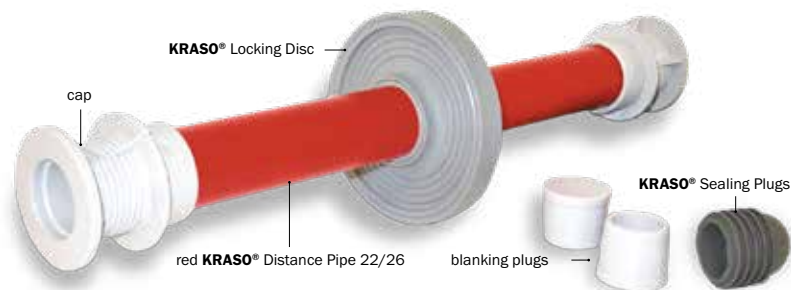

KRASO® DWS - System - water pressure tight tie point **LG 1**

| DafStB waterproof concrete guideline: stress class 1 + 2

Type / Item	KRASO® DWS - System											
Wall thicknesses in cm	15	17,5	20	24	25	30	35	36,5	40	45	50	60
KRASO® DWS - System	4,30 €	4,40 €	4,40 €	4,50 €	4,50 €	4,60 €	4,70 €	4,70 €	4,80 €	4,90 €	5,00 €	5,30 €

Packing Unit:
50 pcs. - red KRASO® Distance Pipe 22/26 with KRASO® Locking Disc and assembled caps
50 pcs. - KRASO® Sealing Plugs
100 pcs. - blanking plugs

Any wall thickness available at short term! Also available for system tie point 26/30!

KRASO® DWS - Accessories **LG 1**



Type / Item	Insertion Tool	Blanking Plugs	KRASO® Sealing Plugs
Packing Unit	1 pcs.	100 pcs.	50 pcs.
KRASO® DWS - Accessories	12 €	10 €	9 €



KRASO® Floor Drain
Check the installation video
(just scan the QR code!)

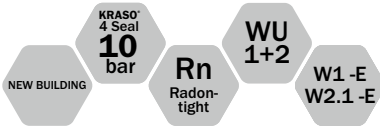

KRASO® Drains for interior and exterior use

Inside and outside – tight and dry

- + For interior areas, basements, yards and parking levels:
KRASO® Drains for a reliable and water pressure tight drainage of pressing water!
- + IAF-tested: Radon-tight!
- + Walkable and fit for traffic, frost proof and odour-tight, backwater safe and thermally insulated:
various versions for different needs!
- + **High-quality components for a secure installation and use:** solid wall material with thermally welded **KRASO® 4 Seal**, plastic or stainless steel grates
- + Additional accessories available as **completion for individual needs**
- + **DafStB waterproof concrete guideline: stress class 1 + 2, with foil flange DIN 18533 W1-E**

KRASO® Drains - according to DIN EN 1253



KRASO®
Floor Drain



KRASO®
Floor Drain with
foil flange



KRASO®
Floor Drain - KG 2000



KRASO®
Floor Drain
- thermally insulated -

KRASO® Floor Drains - frost proof/backwater safe



KRASO®
Floor Drain Type FS
frost proof



KRASO®
Floor Drain Type FS - KG 2000
with foil flange
frost proof



KRASO®
Floor Drain Type FS - RS
frost proof -
backwater safe -



KRASO®
Floor Drain Type FS - RS
with foil flange
frost proof - backwater safe

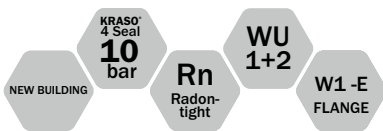

KRASO® Floor Drain **LG 1**

according to DIN EN 1253 – for the installation in interior areas without traffic, for the drainage of grey water, drainage capacity: 1.79 l/s, with water pressure tight surrounding **KRASO® 4 Seal** . Also available with **KRASO® Foil Flange**, oil- and bitumen resistant (d = approx. 50 cm). For the integration of the foil flange, we recommend our adhesive and sealant **KRASO® PU 50** . | **DafStB waterproof concrete guideline: stress class 1 + 2, with foil flange DIN 18533 W1-E**

Type / Item	KRASO® Floor Drain • KRASO® Floor Drain with foil flange
Drainage capacity	1.79 l/s
Height	drain approx. 110 mm
Insert frame	steplessly rotatable and height-adjustable from 30 - 70 mm
Plastic grate (standard)	class K3 (withstands loads up to 300 kg), 15 x 15 cm
Connection	KG/HT - pipes either DN 50 or DN 110 vertical
KRASO® Floor Drain	89 €
KRASO® Floor Drain with foil flange	130 €
KRASO® PU 50	22 €

Scope of supply: **KRASO® Floor Drain**, plastic grate class K3, odour stopper, sludge trap filter, building period protective cover • **KRASO® Floor Drain with foil flange**, plastic grate class K3, odour stopper, sludge trap filter, building period protective cover

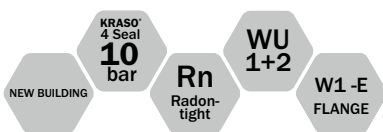

KRASO® Floor Drain - KG 2000 **LG 1**

according to DIN EN 1253 – for the installation in interior areas without traffic, for the drainage of grey water, drainage capacity: 1.79 l/s, with water pressure tight surrounding, thermally welded **KRASO® 4 Seal** . Also available with **KRASO® Foil Flange**, oil- and bitumen resistant (d = approx. 50 cm). For the integration of the foil flange, we recommend our adhesive and sealant **KRASO® PU 50** . | **DafStB waterproof concrete guideline: stress class 1 + 2, with foil flange DIN 18533 W1-E**

Type / Item	KRASO® Floor Drain - KG 2000 • KRASO® Floor Drain - KG 2000 with foil flange
Drainage capacity	1.79 l/s
Height	drain approx. 110 mm
Insert frame	steplessly rotatable and height-adjustable from 30 - 70 mm
Plastic grate	class K3 (withstands loads up to 300 kg), 15 x 15 cm
Connection	KG 2000/HT pipes either DN 50 or DN 110 vertical
KRASO® Floor Drain - KG 2000	113 €
KRASO® Floor Drain - KG 2000 with foil flange	152 €
KRASO® PU 50	22 €

Scope of supply: **KRASO® Floor Drain - KG 2000**, plastic grate class K3, odour stopper, sludge trap filter, building period protective cover • **KRASO® Floor Drain - KG 2000 with foil flange**, plastic grate class K3, odour stopper, sludge trap filter, building period protective cover

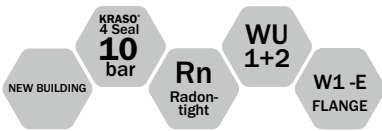

KRASO® Floor Drain - thermally insulated - **LG 1**

according to DIN EN 1253 – for the installation in interior areas without traffic, for the drainage of grey water, drainage capacity: 1.79 l/s, with water pressure tight surrounding thermally welded **KRASO® 4 Seal** | **DafStB waterproof concrete guideline: stress class 1 + 2, with foil flange DIN 18533 W1-E**

Type / Item	KRASO® Floor Drain - thermally insulated -
Drainage capacity	1.79 l/s
Height	drain approx. 110 mm
Insert frame	steplessly rotatable and height-adjustable from 30 - 70 mm
Stainless steel grate	class K3 (withstands loads up to 300 kg), 15 x 15 cm
Connection	either KG/HT - pipes or KG 2000 pipes DN 50 or DN 110 vertical
KRASO® Floor Drain - thermally insulated -	315 €

Scope of supply: KRASO® Floor Drain - thermally insulated -, stainless steel grate class K3, with odour stopper and sludge trap filter, building period protective cover

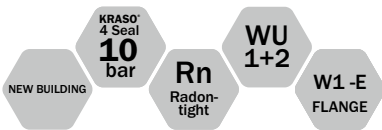

KRASO® Floor Drain Type FS - frost proof **LG 1**

for the installation in exterior areas without traffic, for the drainage of grey water, drainage capacity: 1.67 l/s, with water pressure tight surrounding **KRASO® 4 Seal** . Also available with **KRASO® Foil Flange**, oil- and bitumen resistant (d = approx. 50 cm). For the integration of the foil flange, we recommend our adhesive and sealant **KRASO® PU 50**. | **DafStB waterproof concrete guideline: stress class 1 + 2, with foil flange DIN 18533 W1-E**

Type / Item	KRASO® Type FS • KRASO® Type FS with foil flange
Drainage capacity	1.67 l/s
Height	drain approx. 110 mm
Insert frame	steplessly rotatable and height-adjustable from 30 - 70 mm
Stainless steel grate	class K3 (withstands loads up to 300 kg), 15 x 15 cm
Connection	KG/HT - pipes DN 110 vertical
KRASO® Type FS	186 €
KRASO® Type FS with foil flange	228 €
KRASO® PU 50	22 €

Scope of supply: KRASO® Floor Drain Type FS, screwable stainless steel grate class K3, frost proof odour barrier, sludge trap filter and building period protective cover • KRASO® Floor Drain Type FS with foil flange, screwable stainless steel grate class K3, frost proof odour barrier, sludge trap filter and building period protective cover

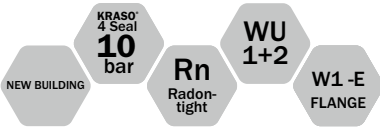

KRASO® Floor Drain Type FS - KG 2000 - frost proof **LG 1**

for the installation in exterior areas without traffic, for the drainage of grey water, drainage capacity: 1.67 l/s, with water pressure tight surrounding, thermally welded **KRASO® 4 Seal**. Also available with **KRASO® Foil Flange**, oil- and bitumen resistant (d = approx. 50 cm). For the integration of the foil flange, we recommend our adhesive and sealant **KRASO® PU 50**. | **DafStB waterproof concrete guideline: stress class 1 + 2, with foil flange DIN 18533 W1-E**

Type / Item	KRASO® Type FS - KG 2000 • KRASO® Type FS - KG 2000 with foil flange
Drainage capacity	1.67 l/s
Height	drain approx. 110 mm
Insert frame	steplessly rotatable and height-adjustable from 30 - 70 mm
Stainless steel grate	class K3 (withstands loads up to 300 kg), 15 x 15 cm
Connection	KG 2000/HT pipes DN 110 vertical
KRASO® Type FS - KG 2000	208 €
KRASO® Type FS - KG 2000 with foil flange	251 €
KRASO® PU 50	22 €

Scope of supply: **KRASO® Floor Drain Type FS - KG 2000**, screwable stainless steel grate class K3, frost proof odour barrier, sludge trap filter and building period protective cover • **KRASO® Floor Drain Type FS - KG 2000 with foil flange**, screwable stainless steel grate class K3, frost proof odour barrier, sludge trap filter and building period protective cover



KRASO® Floor Drain - Accessories **LG 1**



Type / Item	Insert frame extension	Insert frame extension with foil flange	Insert frame extension - fit for traffic up to 1.5 t
Item description	height > 140 mm	height > 140 mm foil flange (d = approx. 50 cm)	steplessly height-adjustable from 15 - 120 mm, all visible parts made of stainless steel, stainless steel grate massive, screwed, 150 x 150 mm, fit for traffic up to 1.5 t, L 15
KRASO® Floor Drain - Accessories	21 €	61 €	180 €



Type / Item	Insert frame	Stainless steel grate	Stainless steel grate - screwable -
Item description	all visible parts made of stainless steel incl. stainless steel grate	class K3	incl. Insert frame with threaded sleeves
KRASO® Floor Drain - Accessories	158 €	36 €	63 €

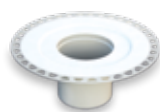

Type / Item	Raising element for thin-bed mortar	Spare parts kit	Floor Drain Insert frame with building period protective cover
Item description	screed structure height from 25 - 130 mm	including: backflow seal, odour stopper, sludge trap filter, Insert frame and plastic grate	for industry floors treated with a power trowel
KRASO® Floor Drain - Accessories	114 €	49 €	107 €

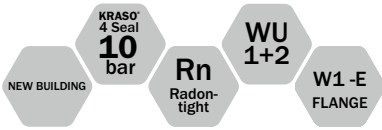

KRASO® Floor Drain Type FS - RS frost proof - backwater safe

- + For installation in outdoor areas for areas without traffic, for the drainage of grey water, drainage capacity: 0.4 l/s.
- + Winterproof due to frost proof backwater double stopper
- + KG 2000: high impact strength and durability
- + Screwable stainless steel grate: class K3 up to max. 300 kg.
- + DafStB waterproof concrete guideline: stress class 1 + 2, with foil flange DIN 18533 W1-E

KRASO® Floor Drain Type FS - RS with screwable stainless steel grate class K3, frost proof backwater double stopper, 2 automatically sealing caps, one of them as emergency valve/closable by one hand, sludge trap filter and building period protective cover



KRASO® Floor Drain Type FS - RS - frost proof backwater safe **LG 1**

for the installation in exterior areas without traffic. Also available with **KRASO® Foil Flange**, oil- and bitumen resistant (d = approx. 50 cm). For the integration of the foil flange, we recommend our adhesive and sealant **KRASO® PU 50**. | DafStB waterproof concrete guideline: stress class 1 + 2, with foil flange DIN 18533 W1-E

Type / Item	KRASO® Type FS - RS • KRASO® Type FS - RS with foil flange
Drainage capacity	0.4 l/s
Height	drain approx. 195 mm
Insert frame	steplessly rotatable and height-adjustable from 30 - 70 mm
Stainless steel grate	class K3 (withstands loads up to 300 kg), 15 x 15 cm
Connection	KG/HT - pipes either DN 50 or DN 110 vertical
KRASO® Type FS - RS	338 €
KRASO® Type FS - RS with foil flange	374 €
KRASO® PU 50	22 €

Scope of supply: **KRASO® Floor Drain Type FS - RS**, screwable stainless steel grate class K3, frost proof backwater double stopper, with 2 automatically closing caps, one of them as emergency valve/closable by one hand, sludge trap filter and building period protective cover • **KRASO® Floor Drain Type FS - RS with KRASO® Foil Flange**, screwable stainless steel grate class K3, frost proof backwater double stopper, with 2 automatically closing caps, one of them as emergency valve/closable by one hand, sludge trap filter and building period protective cover

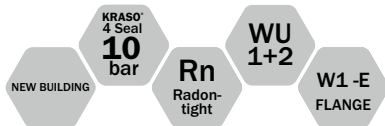

KRASO® Basement Drain

For a dry basement

- + **KRASO® Basement Drain with integrated, removable backwater and odour stopper!**
- + For the connection of up to **3 intake pipes!**
- + Drainage capacity: **1.8 l per second!**
- + With **height-adjustable insert frame** from 30 to 60 mm
- + Either with **plastic or stainless steel grate.**
- + With water pressure tight surrounding, thermally welded **KRASO® 4 Seal: Water pressure tight up to 10 bar!**
- + Also available in **KG 2000: made of polypropylene (PP), mineral-filled, smooth walls, long-lasting.**
- + **DafStB waterproof concrete guideline: stress class 1 + 2, with foil flange DIN 18533 W1-E**



KRASO® Basement Drain **LG 1**

for the installation in areas without traffic and for the connection of up to 3 intake pipes. Also available with **KRASO® Foil Flange**, oil- and bitumen resistant (d = approx. 50 cm). For the integration of the foil flange, we recommend our adhesive and sealant **KRASO® PU 50**. | **DafStB waterproof concrete guideline: stress class 1 + 2, with foil flange DIN 18533 W1-E**

Type / Item	KRASO® Basement Drain with plastic grate	KRASO® Basement Drain with stainless steel grate
Drainage capacity	1,8 l/s	
Height	drain approx. 250 mm	
Insert frame	steplessly rotatable and height-adjustable from 30 - 60 mm	
Slot grate	class K3, 20 x 20 cm, plastic (black)	class K3, 20 x 20 cm, stainless steel
Connection	3 intake pipes: 2 x DN 50, 1 x DN 70, either for KG, HT or KG 2000 pipes	
KRASO® Basement Drain	431 €	545 €
KRASO® Basement Drain with foil flange	560 €	673 €
KRASO® PU 50	22 €	

Scope of supply: **KRASO®** Basement Drain with removable backwater stopper, integrated odour stopper, sludge trap filter and insert frame (telescopically height-adjustable from 30 to 60 mm and rotatable), two intakes DN 50, one intake DN 70, all intakes and drains either for KG, HT or KG 2000 pipes, with slot grate 20 x 20 cm made of black plastic or stainless steel, class K3 • **KRASO®** Basement Drain with foil flange, with removable backwater stopper, integrated odour stopper, sludge trap filter and insert frame (telescopically height-adjustable from 30 to 60 mm and rotatable), two intakes DN 50, one intake DN 70, all intakes and drains either for KG, HT or KG 2000 pipes, with slot grate 20 x 20 cm made of black plastic or stainless steel, class K3 300 kg

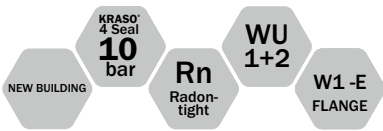

KRASO® Basement Drain - KG 2000 **LG 1**

for the installation in areas without traffic and for the connection of up to 3 intake pipes, for the drainage of grey water, drainage capacity: 1.8 l/s, with water pressure tight surrounding, thermally welded **KRASO® 4 Seal**, lateral **KRASO® Drainage Bows DN 110** with **KRASO® 3 Seal**. Also available with **KRASO® Foil Flange**, oil- and bitumen resistant (d = approx. 50 cm). For the integration of the foil flange, we recommend our adhesive and sealant **KRASO® PU 50**. | DafStB waterproof concrete guideline: stress class **1 + 2**, with foil flange **DIN 18533 W1-E**

Type / Item	KRASO® Basement Drain - KG 2000 with plastic grate	KRASO® Basement Drain - KG 2000 with stainless steel grate
Drainage capacity	1.8 l/s	
Height	drain approx. 250 mm	
Insert frame	steplessly rotatable and height-adjustable from 30 - 60 mm	
Slot grate	class K3, 20 x 20 cm, plastic (black)	class K3, 20 x 20 cm, stainless steel
Connection	3 intake pipes: 2 x DN 50, 1 x DN 70, either for KG, HT or KG 2000 pipes	
KRASO® Basement Drain - KG 2000	539 €	682 €
KRASO® Basement Drain - KG 2000 with foil flange	668 €	781 €
KRASO® PU 50	22 €	

Scope of supply: **KRASO® Basement Drain - KG 2000** with removable backwater stopper, integrated odour stopper, sludge trap filter and insert frame (telescopically height-adjustable from 30 to 60 mm and rotatable), two intakes DN 50, one intake DN 70, all intakes and drains either for KG, HT or KG 2000 pipes, with slot grate 20 x 20 cm made of black plastic or stainless steel, class K3 •

KRASO® Basement Drain - KG 2000 with foil flange with removable backwater stopper, integrated odour stopper, sludge trap filter and insert frame (telescopically height-adjustable from 30 to 60 mm and rotatable), two intakes DN 50, one intake DN 70, all intakes and drains either for KG, HT or KG 2000 pipes, with slot grate 20 x 20 cm made of black plastic or stainless steel, class K3 300 gw



KRASO® Drains - Accessories **LG 1**

Type / Item	Insert frame extension for KRASO® Basement Drain, KRASO® Yard Drain Type 12.5, height-adjustable from 46 - 130 mm, also suitable for KRASO® Yard/Parking Level Drain Type 1.5 with stainless steel grate	Insert frame extension for KRASO® Yard/Parking Level Drain Type 1.5 ¹ height-adjustable from min. 25 - 130 mm
Item description		
KRASO® Drains - accessories	30 €	99 €

¹ not suitable for **KRASO® Yard/Parking Level Drain Type 1.5** with stainless steel grate



KRASO® PU 50 **LG 1**

high-quality, permanently elastic and strong PU-sealant, also usable on moist surfaces, recommended for all products with **KRASO® Foil Flange**, colour black, 290 ml - cartridge for cartridge press



Type / Item	PU sealant
KRASO® PU 50	22 €

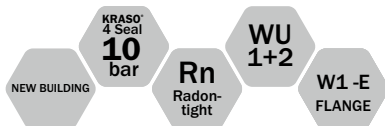

KRASO® Yard/Parking Level Drain

The high-performance drain for e.g. underground car parks

- + KRASO® Yard/Parking Level Drain with 4.3 l/s drainage capacity according to DIN EN 1253.
- + With frost proof odour barrier and removable sand trap basket.
- + Load class A to 1.5 t or load class B up to 12.5 t.
- + Connection either for KG, HT or KG 2000 pipes DN 110.
- + With water pressure tight surrounding, thermally welded KRASO® 4 Seal :
Water pressure tight up to 10 bar!
- + DafStB waterproof concrete guideline: stress class 1 + 2, with flange DIN 18533 W1-E



KRASO® Yard/Parking Level Drain Type 1.5



KRASO® Yard/Parking Level Drain Type 1.5 with trowel flange with dovetail groove (only for welding sheets, not for resin coating)



KRASO® Yard/Parking Level Drain Type 1.5 with stainless steel grate



KRASO® Yard/Parking Level Drain Type 1.5 with stainless steel grate with foil flange



KRASO® Yard/Parking Level Drain Type 12.5



KRASO® Yard/Parking Level Drain Type 12.5 with stainless steel grate

KRASO® Yard/Parking Level Drain **LG 1**

for the installation in areas with traffic

Type / Item	KRASO® Yard/Parking Level Drain Type 1.5	KRASO® Yard/Parking Level Drain Type 12.5
Drainage capacity	4.3 l/s	
Load class	load class A 15	load class B to 12.5 t
Base plate thickness	min. 20 cm	min. 15 or 20 cm
Connection	either for KG, HT or KG 2000 pipes DN 110	
KRASO® Yard/Parking Level Drain	282 €	511 €
KRASO® Yard/Parking Level Drain with trowel flange with dovetail groove	471 €	-
KRASO® Yard/Parking Level Drain with stainless steel grate	444 €	-
KRASO® Yard/Parking Level Drain with stainless steel grate with foil flange	632 €	-
KRASO® Yard/Parking Level Drain with stainless steel grate	-	708 €

Scope of supply: KRASO® Yard/Parking Level Drain Type 1.5 with frost proof odour barrier, removable sand trap basket, with slot grate approx. 24 x 24 cm, cast iron, load class A to 1.5 t, vertical discharge • KRASO® Yard/Parking Level Drain Type 12.5 with frost proof odour barrier, removable sand trap basket, with support frame made of eco-cast, 26 x 26 cm, with slot grate, load class B up to 12.5 t, vertical discharge

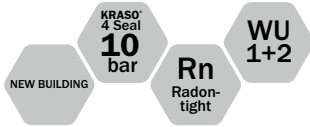

KRASO® Type LES

Light shaft drainage system for concrete shafts

- + Flexible drainage system - for precast elements and in-situ concrete
- + Various components for individual demands
- + Also available for retrofit installation
- + DafStB waterproof concrete guideline: stress class 1 + 2



KRASO® Type LES DN 160 - Basis for precast elements
with water pressure tight surrounding, thermally welded **KRASO® 2 Seal**. For later installation of LES - vario - connection, LES - leaf sieve and LES - odour barrier



KRASO® Type LES DN 160 - Basis for in-situ concrete
with water pressure tight surrounding, thermally welded **KRASO® 4 Seal**. For later installation of LES - vario - connection, LES - leaf sieve and LES - odour barrier



KRASO® Type LES DN 160 - Vario connection
connection either to drainage DN 50 / DN 110 or to drainage DN 110. Connection possible to LES - backwater double stopper



LES DN 160 - odour barrier
removable, frost proof



LES DN 160 - backwater double stopper
with 2 automatically sealing caps, one of them as emergency valve/closable by one hand, easily accessible and easy to maintain. Can be retrofitted by LES - Vario - connection. Drainage capacity: 0.4 l/s
Backwater tight up to 5 m water column



LES DN 110 - backwater stopper



LES DN 110 and DN 160 - leaf sieve

KRASO® Type LES - light shaft drainage system **LG 1**

for concrete shafts | DafStB waterproof concrete guideline: stress class 1 + 2

Type / Item	KRASO® Type LES - 110	KRASO® Type LES - 160
KRASO® Type LES - basis for precast elements	47 €	53 €
KRASO® Type LES - basis for in-situ concrete	66 €	78 €
KRASO® Type LES - vario - connection	45 €	53 €
LES - odour barrier	36 €	36 €
LES - backwater stopper	125 €	-
LES - backwater double stopper	-	181 €
LES - leaf sieve	36 €	38 €

Also available for retrofit installation!



The
alternative
to fixed-loose
flange!

NEW BUILDING
REHABILITATION

1,5
bar

W1-E
W2.1-E

KRASO® Flange Pipes

Simple and effective integration into bituminous sealing

- + For new buildings and rehabilitation - according to DIN 18533 W1-E and W2.1-E
- + **Simple and effective integration into bituminous sealing** („black tank“): bitumen thick coating and reactive sealing, sheeting, concrete and brick walls
- + Water pressure tight up to 1.5 bar – MPA-tested!
- + Made of dimensionally and pressure stable solid wall material with low abrasion! Installation even at lower temperatures
- + Pipe and pipe material in accordance with DIN EN 1401 (KG) or DIN EN 14758 (KG 2000)

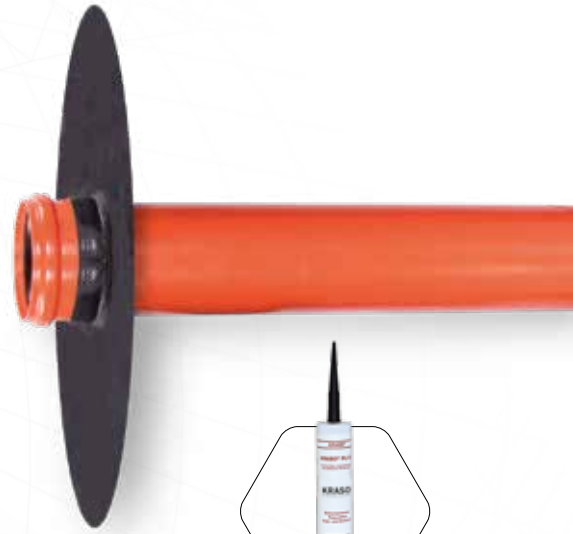

KRASO® PU 50:
high-quality, permanently elastic
and strong PU-sealant!
(290 ml - cartridge).
Our recommendation for all
products with **KRASO®** Foil Flange!



KRASO® Flange Pipe Type KG



KRASO® Flange Pipe Type KG 2000



KRASO® Flange Pipe Type FE



KRASO® Type KMB



KRASO® Type KMB - KG 2000



KRASO® Type ÜSF



KRASO® Flange Pipe Type KG **LG 1**

for retrofit installation, for the connection to KG/HT pipes, made of high-quality, dimensionally and pressure stable solid wall material, with formed plug-in sleeve on one side and **KRASO®** Foil Flange, oil- and bitumen resistant, surrounding approx. 15 cm. For the integration of the foil flange, we recommend our adhesive and sealant **KRASO®** PU 50. | **DIN 18533 W1 -E and W2.1 -E**

Type / Item	KRASO® Flange Pipe Type KG							
Diameter DN	110	125	160	200	250	315	400	500
Delivery length in cm	50							
KRASO® Flange Pipe Type KG	47 €	49 €	62 €	78 €	154 €	230 €	293 €	450 €
KRASO® PU 50	22 €							

Further diameters and lengths from 50 cm available on request!



KRASO® Flange Pipe Type KG 2000 **LG 1**

for retrofit installation, for the connection to KG 2000 pipes, made of high-quality, dimensionally and pressure stable solid wall material, with formed plug-in sleeve on one side and **KRASO®** Foil Flange, oil- and bitumen resistant, surrounding approx. 15 cm. For the integration of the foil flange, we recommend our adhesive and sealant **KRASO®** PU 50. | **DIN 18533 W1 -E and W2.1 -E**

Type / Item	KRASO® Flange Pipe Type KG 2000							
Diameter DN	110	125	160	200	250	315	400	500
Delivery length in cm	50							
KRASO® Flange Pipe Type KG 2000	62 €	79 €	87 €	122 €	279 €	389 €	499 €	652 €
KRASO® PU 50	22 €							

Further diameters and lengths from 50 cm available on request!



KRASO® Flange Pipe Type FE **LG 1**

thick-walled true diameter plastic casing for retrofit installation of pipes and cables using a sealing insert (not included in the scope of supply), with **KRASO®** Foil Flange, oil- and bitumen resistant, surrounding approx. 15 cm. For the integration of the foil flange, we recommend our adhesive and sealant **KRASO®** PU 50. ID = InternalDiameter flange pipe Type FE | **DIN 18533 W1 -E and W2.1 -E**

Type / Item	KRASO® Flange Pipe Type FE					
InternalDiameter ID	100	125	150	200	250	300
External diameter in mm	110	140	160	210	263	314
Delivery length in cm	50					
KRASO® Flange Pipe Type FE	45 €	49 €	56 €	80 €	113 €	134 €
KRASO® PU 50	22 €					

Further diameters and lengths from 50 cm available on request!



KRASO® Type KMB **LG1**

plug-in flange, for retrofit sealing of KG/HT pipes using **KRASO®** Foil Flange with bitumen thick coating and reactive sealings, with formed plug-in sleeve on one side and **KRASO®** Foil Flange, oil- and bitumen resistant, surrounding approx. 6 cm. For the integration of the foil flange, we recommend our adhesive and sealant **KRASO®** PU 50. | **DIN 18533 W1 -E and W2.1 -E**

Type / Item	KRASO® Type KMB			
Diameter DN	110	125	160	200
Plug-in length in cm	7	7,5	8	9
KRASO® Type KMB	49 €	52 €	63 €	80 €
KRASO® PU 50	22 €			

Further diameters available on request!



KRASO® Type KMB - KG 2000 **LG1**

plug-in flange, for retrofit sealing of KG 2000 pipes using **KRASO®** Foil Flange with bitumen thick coating and reactive sealings, with formed plug-in sleeve on one side and **KRASO®** Foil Flange, oil- and bitumen resistant, surrounding approx. 6 cm. For the integration of the foil flange, we recommend our adhesive and sealant **KRASO®** PU 50. | **DIN 18533 W1 -E and W2.1 -E**

Type / Item	KRASO® Type KMB - KG 2000			
Diameter DN	110	125	160	200
Plug-in length in cm	7	7,5	8	9
KRASO® Type KMB - KG 2000	60 €	70 €	85 €	122 €
KRASO® PU 50	22 €			

Further diameters available on request!



KRASO® Type ÜSF - slip-on flange **LG1**

for retrofit sealing of installed KG, HT or KG 2000 pipes, using **KRASO®** Foil Flange with bitumen sealing (e.g. KMB), with foil flange, oil- and bitumen resistant, surrounding approx. 15 cm. For the integration of the foil flange, we recommend our adhesive and sealant **KRASO®** PU 50. | **DIN 18533 W1 -E and W2.1 -E**

Type / Item	KRASO® Type ÜSF					
Diameter DN	110	125	160	200	250	315
KRASO® Type ÜSF	87 €	95 €	113 €	208 €	307 €	411 €
KRASO® PU 50	22 €					

Further diameters available on request!



Floor

Floor Penetration Type FBV-BDF (p. 108)

Wall

Wall Penetration Type FBV-FR (p. 109) + Casing Type FBV-FE (p. 110) +
Sealing Insert Type FBV/GF (p. 111) + Cable Penetration FBV-KDS (p. 112)

Concrete

Fresh concrete composite (FBV) solutions made of concrete –
pump sumps, lift pits, cable ducts (p. 113)

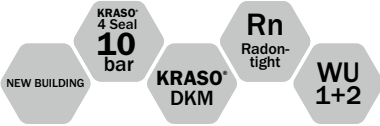

KRASO® Floor Penetration Type FBV-BDF

The effective sealing system

- + Floor penetration for an **integration into the fresh concrete composite system in compliance with the system**
- + Independent of the manufacturer: fresh concrete composite films (FBV) from any manufacturer can be integrated into the system at the factory
- + **KRASO® FBV Sealing Flange** made of non-corrosive stainless steel V2A with 20 cm surrounding, square fresh concrete composite film
- + Torque Control Nut **KRASO® DKM**: **integrated torque limiter - no torque wrench required!**
- + **KRASO® Floor Penetration Type BDF**: the proven floor penetration with **KRASO® 4 Seal** – MPA-tested up to **10 bar!**
- + **IAF-tested: Radon-tight!**
- + Made of **dimensionally and pressure stable solid wall material with low abrasion!**
Installation even at lower temperatures!
- + Also available in **KG 2000**: made of polypropylene (PP), mineral-filled, smooth walls, long-lasting
- + Formed plug-in sleeve on one side **for the connection from KG, HT or KG 2000 pipes**
- + Including **KRASO® Cover** as building period protective cover
- + **DafStB waterproof concrete guideline: stress class 1 + 2**



KRASO® Floor Penetration Type FBV-BDF **LG 1**

floor penetration for a compliant integration of fresh concrete composite films (FBV) | **DafStB waterproof concrete guideline: stress class 1 + 2**

Type / Item	KRASO® Type FBV-BDF • KRASO® Type FBV-BDF - KG 2000							
	110	125	160	200	250	315	400	500
Diameter DN	110	125	160	200	250	315	400	500
Delivery length (in cm)	50							
KRASO® Type FBV-BDF	246 €	302 €	309 €	418 €	605 €	724 €	937 €	1.150 €
KRASO® Type FBV-BDF - KG 2000	253 €	312 €	325 €	447 €	702 €	822 €	1.071 €	1.302 €

Scope of supply: KRASO® Type FBV-BDF or KRASO® Type FBV-BDF - KG 2000, KRASO® Cover as building period protective cover, KRASO® FBV Sealing Flange with 20 cm surrounding, square fresh concrete composite film

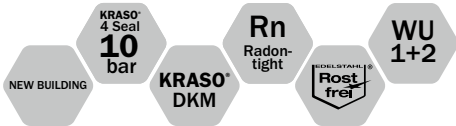

KRASO® Wall Penetration Type FBV-FR

Always the right flow direction using FBV system

- + Wall penetration for a **compliant integration of fresh concrete composite films**
- + Independent of the manufacturer: fresh concrete composite films (FBV) from any manufacturer can be integrated into the system at our factory
- + **KRASO® FBV Sealing Flange** made of non-corrosive stainless steel V2A with 20 cm surrounding, square fresh concrete composite film
- + Torque Control Nut **KRASO® DKM**: integrated torque limiter - no torque wrench required!
- + Thanks to the **KRASO® Wall Penetration Type FR**, waste water always maintains the correct flow direction! Unnecessary edges are prevented. **Blocked pipes: impossible!**
- + Due to the **flexible yet water pressure tight connection** to the pipe system, stresses occurring through the setting of the KG pipes are **minimised!**
- + **The basement remains dry and is protected against radon thanks to the up to 10 bar water pressure tight surrounding KRASO® 4 Seal!**
- + **Made of solid wall material!** Also available in KG 2000 made of polypropylene (PP), mineral-filled, smooth walls, long-lasting
- + **DafStB waterproof concrete guideline: stress class 1 + 2**



KRASO® Wall Penetration Type FBV-FR - flow direction **LG 1**

wall penetration for a compliant integration of fresh concrete composite film | **DafStB waterproof concrete guideline: stress class 1 + 2**

Type / Item	KRASO® Type FBV-FR		
Diameter DN	110	125	160
Available standard wall thicknesses in cm	20 ¹ · 24 · 25 · 30		
KRASO® Type FBV-FR	309 €	315 €	420 €
KRASO® Type FBV-FR - KG 2000	324 €	330 €	449 €

¹ wall thickness 20 cm only available in DN 110, not available as KG 2000

Scope of supply: KRASO® Type FBV-FR or KRASO® Type FBV-FR - KG 2000, 2 KRASO® Covers as an installation aid, KRASO® FBV Sealing Flange with 20 cm surrounding, square fresh concrete composite film

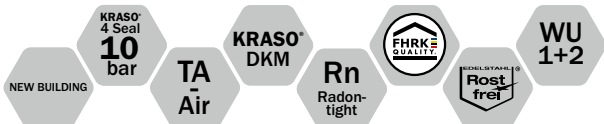

KRASO® Casing Type FBV-FE

The casing for FBV integration

- + Casing for a **compliant integration of fresh concrete composite films**
- + Independent from the manufacturer: fresh concrete composite films (FBV) of all manufacturers can be integrated
- + **KRASO® FBV Sealing Flange** made of non-corrosive stainless steel V2A with 20 cm surrounding, square fresh concrete composite film
- + Torque Control Nut **KRASO® DKM**: **integrated torque limiter - no torque wrench required!**
- + The thick-walled true diameter plastic casing for concreting:
as a recess for retrofit installation of cables or pipes using a sealing insert!
- + With **water pressure tight surrounding KRASO® 4 Seal** – **certified and approved**: due to the special geometry, the 4 Seal produces a water pressure, gas- and odour-tight grip with the concrete
- + **Material and processing: KRASO® Casings** are made of **weatherproof and impact resistant plastic**.
The water pressure tight surrounding **KRASO® 4 Seal** is joined monolithically to the plastic pipe by vulcanization.
- + **IAF-tested: Radon-tight!**
- + **Tested in accordance with FHRK test specification GE 102!**
- + **DafStB waterproof concrete guideline: stress class 1 + 2**

KRASO® Casing Type FBV-FE - true diameter casing **LG 1**

thick-walled plastic casing for a compliant integration of FBF films | DafStB waterproof concrete guideline: stress class 1 + 2

Type / Item	KRASO® Type FBV-FE					
InternalDiameter ID	100	125	150	200	250	300
Available standard wall thicknesses in cm	20 · 24 · 25 · 30 · 35 · 36,5 · 40 · 45 · 50					
KRASO® Type FBV-FE	245 €	302 €	304 €	418 €	564 €	638 €

Scope of supply: KRASO® Casing Type FBV-FE, 2 KRASO® Covers as an installation aid, KRASO® FBV Sealing Flange with 20 cm surrounding, square fresh concrete composite film

Further diameters and wall thicknesses available on request!

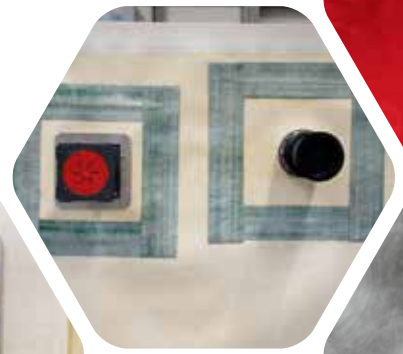

butyl sealing band



KRASO® Sealing Insert Type FBV/GF **LG 1**

for installation of pipes or cables, for casing or core drilling, with large flange and additional sealing flange incl. butyl sealing band for the integration of FBV films, Torque Control Nut **KRASO® DKM***, non-corrosive stainless steel V2A, against pressing water up to 2.5 bar | **DafStB waterproof concrete guideline: stress class 1 + 2**

Core drilling / casing in mm (from - to)	80 (79 - 83)	100 (99 - 103)	125 (124 - 128)	150 (149 - 153)	200 (198 - 203)	250 (248 - 253)	300 (298 - 303)	350 (348 - 353)	400 (398 - 403)	450 (448 - 453)	500 (497 - 503)
max. external diameter pipe or cable											
from	0	0	0	0	0	0	0	0	0	0	0
to	55	75	100	125	175	225	275	325	375	425	475
KRASO® Type FBV/GF											
KRASO® Type FBV/GF	384 €	448 €	499 €	585 €	730 €	907 €	1.143 €	1.333 €	1.578 €	1.789 €	1.987 €
Surcharge: additional drilling	up to 5 drillings each additional drilling 17 €, each further additional drilling 11 €										

* In some cases, allen screws must be used due to the design

All sizes and diameters available on request!

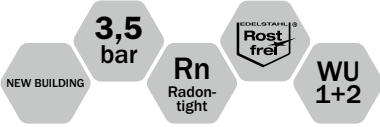
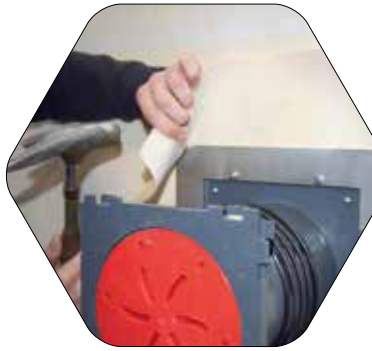

KRASO® Cable Penetration FBV-KDS double wall penetration as FBV system

- + Cable penetration for the **compliant integration of fresh concrete composite films**
- + Independent from the manufacturer: fresh concrete composite films (FBV) of all manufacturers can be integrated
- + **KRASO® FBV Sealing Flange** made of non-corrosive stainless steel V2A with 20 cm surrounding, square fresh concrete composite film
- + **Compatible** with all other current systems! **Tight** due to the water pressure tight surrounding **KRASO® 4 Seal!**
Secure due to break-resistant solid wall material!
- + The **intelligent, all-purpose and flexible cable penetration system** for complex construction projects: **public buildings, hospitals, technical-scientific institutions or industrial and commercial sectors**
- + **With plug-in system on both sides for forming packages!**
- + **DafStB waterproof concrete guideline: stress class 1 + 2**

KRASO® Cable Penetration FBV-KDS double wall penetration **LG 1**

cable penetration system for concreting | DafStB waterproof concrete guideline: stress class 1 + 2

Type / Item	KRASO® Cable Penetration FBV-KDS double wall penetration										
Available standard wall thicknesses in cm	15	17,5	20	24	25	30	35	36,5	40	45	50
KRASO® Cable Penetration FBV-KDS 90 double wall penetration	343 €										
KRASO® Cable Penetration FBV-KDS 150 double wall penetration	491 €										

Scope of supply: KRASO® FBV-KDS 90 or KRASO® FBV-KDS 150 double wall penetration, 2 KDS closure covers, KRASO® FBV Sealing Flange with 20 cm surrounding, square fresh concrete composite film



Precast concrete elements with FBV film: ready for the integration into the FBV system



NEW BUILDING

KRASO® FBV solutions made of concrete pump sumps, lift pits, inspections shafts

- + Precast concrete elements as special designs for a compliant integration of fresh concrete composite films: pump sumps, lift pits, cable ducts, inspection shafts
- + Complete foil cover for integration into the base plate!
Manufacturer-independent: fresh concrete composite films (FBV) of all manufacturers can be integrated
- + Weather-independent production, completely custom-made exactly according to your instructions!
- + The surrounding water pressure tight construction joint tape KRASOflex® Duo-Fix 150 „plus“ ensures a water pressure tight passage to the base plate
- + Simple and fast placement on-site thanks to crane lifting lugs!



**Solid wall
material
means security
and
stability**

KRASO® solid wall material

- pressure and dimensionally stable
- break-resistant
- impact resistant
- low abrasion
- installation also at low temperatures

foamed material

lower degree of stability in contrast to our pipe penetrations made of solid wall material.



+ **KRASO® Pipe Penetrations** made of solid wall material are **very pressure resistant and dimensionally stable in contrast to pipes made of foamed material!** **Breakage resistance, impact resistance as well as low abrasion are further advantages** for the hard everyday operations on the construction-site. **KRASO® Pipe Penetrations** are also easy to install at low temperatures.

+ Pipes and pipe material of our floor and wall penetrations are in accordance with the terms of **DIN EN 1401 (KG)** or **DIN EN 14758 (KG 2000)**.

+ The monolithic (force-fit) fusion with the solid wall pipe **prevents any creep or slippage.**

Due to the special geometry, the **KRASO® 4 Seal** produces a **grip with the concrete.**

+ **MPA-tested quality:** the material testing institute MPA certifies a **water pressure tightness up to 10 bar!**

**KRASO®
4 Seal:
tight against pressing
water up to
10 bar!**



Concrete

Pump Sump - concrete - (p. 116) + Inspection Shaft - concrete - (p. 121)

Plastic

Pump Sump Type Q - square - (p. 117) + Backwater Shaft Type Q - sewage - (p. 121) +
Pump Sump Type Q - thermally insulated - (p. 121) + Pump Sump Type Q - sewage - (p. 124) +
Pump Sump Poly 400 - complete - KG 2000 (p. 125) + Pump Sump Poly 400 - KG 2000 (p. 126) +
Pump Sump Poly 400 - LR - KG 2000 (p. 126) + Pump Sump Poly 400 - NE - KG 2000 - retrofit
installation (p. 127) + Poly - Inspection Shaft - KG 2000 (p. 127) + Pressure Shaft 400 - KG 2000 (p. 127) +
Water Shaft (p. 129) + Pump Sump Poly 400 - KG 2000 - Accessories (p. 129)

Covers

Pump Sump Cover - walkable (p. 118) + Pump Sump Cover - walkable -, water and odour tight screwable (p. 119) +
Pump Sump Covers - fit for traffic up to 5 t, wheel pressure up to 1.25 t (p. 119) +
Pump Sump Covers - fit for traffic up to 15 t, wheel pressure up to 3.75 t (p. 120) + Pump Sump Cover -
fillable - (p. 120) + Grating Cover - walkable (p. 120) + Pump Sump Poly 400 - Covers (p. 128)



KRASO® Pump Sump - concrete -
Check the installation video
(just scan the QR code!)

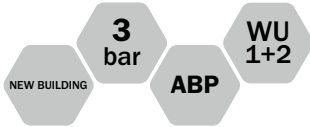

KRASO® Pump Sump - concrete - Saves time and money

- + Avoid formworks on-site - and save time and money - with the **KRASO® Pump Sump** as ready-made concrete element!
- + Made of waterproof concrete (C35/45) in one piece cast - **without additional joints!**
- + 12 cm thick, reinforced walls as well as the surrounding water pressure tight, MPA-tested construction joint tape **KRASOflex® Duo-Fix 150 „plus“** grant a water pressure tight passage to the base plate.
- + Simple and fast placement on-site thanks to crane lifting lugs!
- + DafStB waterproof concrete guideline: stress class 1 + 2

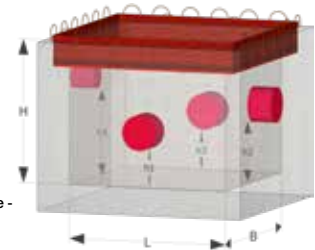

arrangement of connections
ref. standard sizes
KRASO® Pump Sump - concrete -

KRASO® Pump Sump - concrete - **LG 3**

for collecting waste water | DafStB waterproof concrete guideline: stress class 1 + 2

KRASO® Pump Sump - concrete -							
Internal dimensions (l x w x h, in cm)	Weight approx. in kg	Design	Position and diameter of the connection				KRASO® Pump Sump - concrete -
			h1 (in cm)	h2 (in cm)	h3 (in cm)	h4 (in cm)	
60 x 60 x 40	600	standard	15 - DN 110				596 €
		closed					
60 x 60 x 60	700	standard	40 - DN 110	20 - DN 110			656 €
		with one connection	40 - DN 110				
		closed					
80 x 80 x 70	1.100	standard	20 - DN 160	30 - DN 160	20 - DN 160	40 - DN 110	896 €
		with one connection				40 - DN 110	
		closed					
100 x 100 x 80	1.500	standard	50 - DN 160	40 - DN 160	20 - DN 160	40 - DN 110	994 €
		with one connection				40 - DN 110	
		closed					
100 x 100 x 100	1.750	standard				40 - DN 110	1.355 €
		closed					
120 x 120 x 80	1.800	standard	50 - DN 160	20 - DN 160	40 - DN 160	40 - DN 110	1.505 €
		with one connection				40 - DN 110	
		closed					
Surcharge special design with standard internal dimensions*							
connection DN 110						71 €	
connection DN 125						80 €	
connection DN 160						88 €	

* Calculation basis = closed pump sump

Further sizes and connections available as special design on request!



KRASO® Pump Sump Type Q - square -
Check the installation video
(just scan the QR code!)

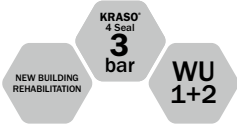

KRASO® Pump Sump Type Q - square - Low weight - quick delivery: the simple and tight plastic solution

- + Low weight = low transport costs and easy handling without crane on-site!
- + Saves time, labour, money and additional drainage: no cost-intensive works, no concreting sections for several days and no shuttering!
- + No risk occurring due to leaking concrete joints and/or pipe connections!
- + Resistant against many acids and lyes!
- + Made of high-quality, impact resistant, almost indestructible plastic. Special dimensions are available within a few days!
- + DafStB waterproof concrete guideline: stress class 1 + 2

KRASO® Pump Sump Type Q - square - LG2

for collecting waste water, suitable for KG, HT and KG 2000 pipes | DafStB waterproof concrete guideline: stress class 1 + 2

Type / Item	600/60	600/80	800/100	1000/100
Internal dimensions in cm	60 x 60	60 x 60	80 x 80	100 x 100
Internal height in cm	60	80	100	100
1x connection DN 110 (height bottom edge in cm)	20	20	30	30
Weight approx. in kg	25	28	53	66
KRASO® Pump Sump Type Q - square -	698 €	819 €	1.178 €	1.420 €
Surcharge: additional connection DN 110	51 €			
Surcharge: additional connection DN 160	78 €			

Further sizes and designs available on request! Modification of the pipe connection height possible!

KRASO® Pump sumps

– delivery to the construction site

- + **KRASO® Pump Sumps** – whether made of concrete or plastic – save time and money!
- + Precise planning of your construction process is possible with a delivery directly to your construction-site. Thanks to pre-installed crane lifting lugs, **KRASO® Pump Sumps** made of concrete can be unloaded and installed easily on the construction-site!

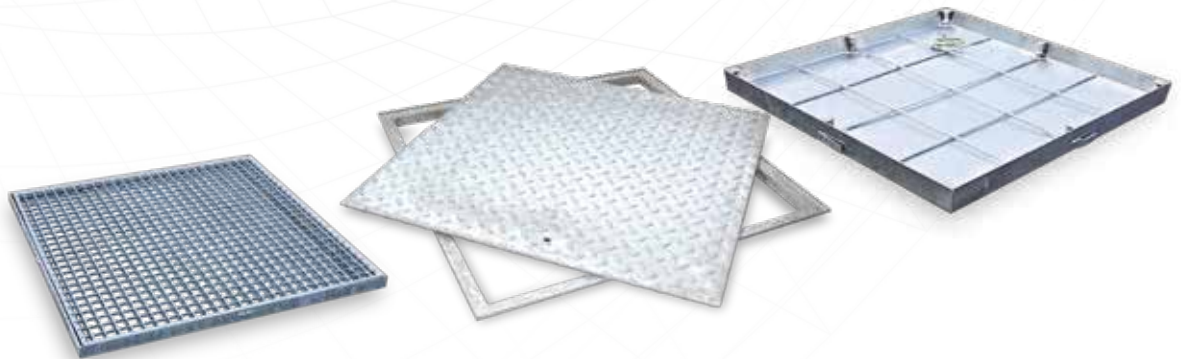

KRASO® Pump Sump Covers

For KRASO® Pump Sump - concrete - and Type Q - square -

KRASO® Pump Sump Cover - walkable **LG 6**

for KRASO® Pump Sump - concrete - and KRASO® Pump Sump Type Q - square -, bulb plate galvanised, walkable

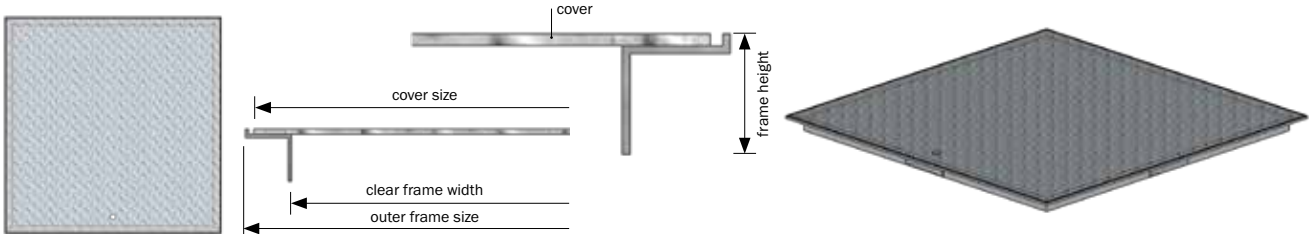

Type/Item	KRASO® Pump Sump Cover - walkable			
Pump sump dimension in cm	60 x 60	80 x 80	100 x 100	120 x 120
Cover size in mm	700 x 700	900 x 900	1100 x 1100	1275 x 1275
Cover thickness approx. in mm	3/5			
Frame height in mm	32	32	32	36
Outer frame size in mm	708 x 708	908 x 908	1108 x 1108	1320 x 1320
Clear frame width in mm	654 x 654	854 x 854	1054 x 1054	1210 x 1210
Concrete anchors / pcs.	4	4	8	8
KRASO® Pump Sump Cover - walkable	167 €	293 €	505 €	905 €

Special designs available on request!

KRASO® Pump Sump Cover - walkable -, water and odour-tight screwable **LG 6**

for KRASO® Pump Sump - concrete - and KRASO® Pump Sump Type Q - square -, bulb plate galvanised, walkable, water and odour-tight screwable

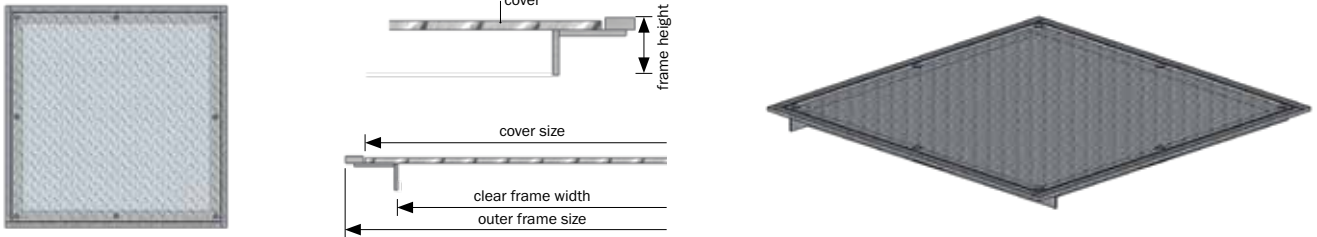

Type/Item	KRASO® Pump Sump Cover - walkable -, water and odour-tight			
Pump sump dimension in cm	60 x 60	80 x 80	100 x 100	120 x 120
Cover size in mm	700 x 700	900 x 900	1100 x 1100	1275 x 1275
Cover in mm	3/5			
Frame height in mm	36			
Outer frame size in mm	745 x 745	945 x 945	1145 x 1145	1320 x 1320
Clear frame width in mm	635 x 635	835 x 835	1035 x 1035	1210 x 1210
Concrete anchors / pcs.	4	4	8	8
KRASO® Pump Sump Cover - walkable -, water/odour tight	457 €	576 €	905 €	1.497 €

Special designs available on request!

KRASO® Pump Sump Cover - fit for traffic up to 5 t, wheel pressure up to 1.25 t **LG 6**

for KRASO® Pump Sump - concrete - and KRASO® Pump Sump Type Q - square -, bulb plate galvanised, fit for traffic up to 5 t, wheel pressure up to 1.25 t

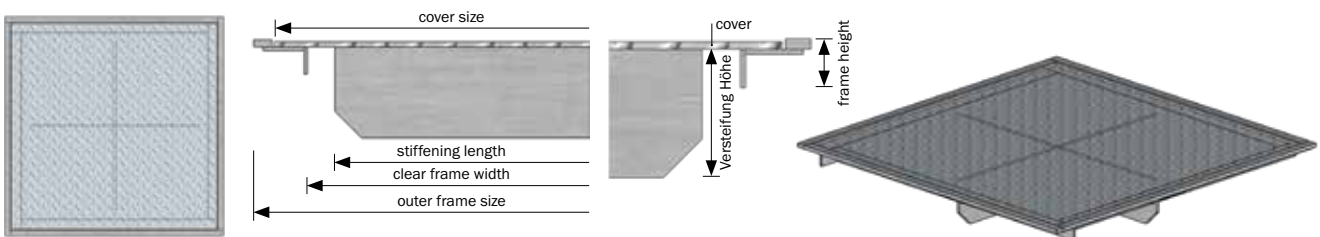

Type/Item	KRASO® Pump Sump Cover - fit for traffic up to 5 t, wheel pressure up to 1.25 t			
Pump sump dimension in cm	60 x 60	80 x 80	100 x 100	120 x 120
Cover size in mm	700 x 700	900 x 900	1100 x 1100	1275 x 1275
Cover in mm	5/7			
Frame height in mm	38			
Outer frame size in mm	745 x 745	945 x 945	1145 x 1145	1320 x 1320
Clear frame width in mm	635 x 635	835 x 835	1035 x 1035	1210 x 1210
Stiffening in mm	7			
Stiffening height in mm	80			
Stiffening quantity	1	2	2	3
Concrete anchors / pcs.	4	4	8	8
KRASO® Pump Sump Cover - fit for traffic up to 5 t, wheel pressure up to 1.25 t	414 €	684 €	1.191 €	1.758 €

Special designs available on request!

KRASO® Pump Sump Cover - fit for traffic up to 15 t, wheel pressure up to 3.75 t **LG 6**

for KRASO® Pump Sump - concrete - and KRASO® Pump Sump Type Q - square -, bulb plate galvanised, fit for traffic up to 15 t, wheel pressure up to 3.75 t

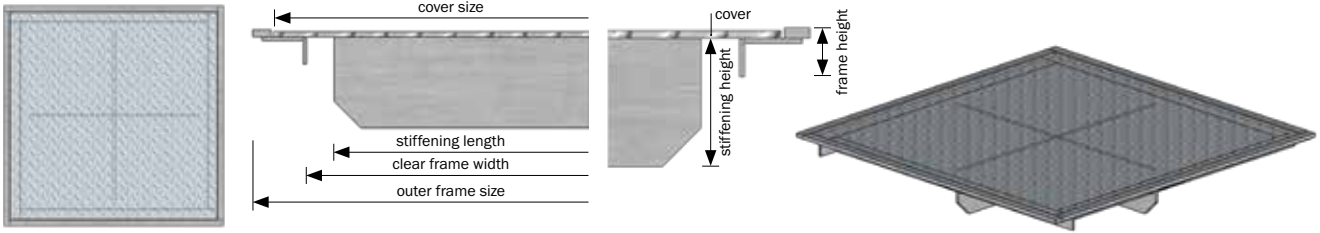

Type/Item	KRASO® Pump Sump Cover - for traffic up to 15 t, wheel pressure up to 3.75 t			
Pump sump dimension in cm	60 x 60	80 x 80	100 x 100	120 x 120
Cover size in mm	700 x 700	900 x 900	1100 x 1100	1275 x 1275
Cover in mm	6/8			
Frame height in mm	38			
Outer frame size in mm	745 x 745	945 x 945	1145 x 1145	1320 x 1320
Clear frame width in mm	635 x 635	835 x 835	1035 x 1035	1210 x 1210
Stiffening in mm	8			
Stiffening height in mm	100			
Stiffening quantity	1	2	2	3
Concrete anchors / pcs.	4	8	8	8
KRASO® Pump Sump Cover - fit for traffic up to 15 t, wheel pressure up to 3.75 t	735 €	1.047 €	1.919 €	2.597 €

Special designs available on request!

KRASO® Pump Sump Cover - fillable - **LG 6**

fillable galvanised tub, water and odour-tight, loading after filling with concrete C 35/45: approx. 125 kN

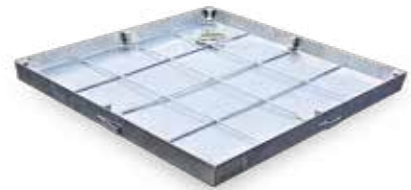

frame profile

h1 = installation height approx. 7,5 cm
h2 = tub depth approx. 5,0 cm

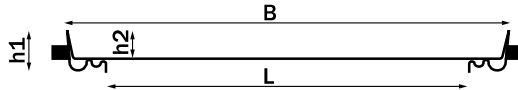

Type / Item	KRASO® Pump Sump Cover - fillable -			
Pump sump dimension in cm	60 x 60	80 x 80	100 x 100	120 x 120
Outer frame size in mm	B	735 x 735	935 x 935	1135 x 1135
Clear frame width in mm	L	600 x 600	800 x 800	1000 x 1000
KRASO® Pump Sump Cover - fillable -	667 €	952 €	1.212 €	on request

Special designs available on request!

KRASO® Grating Cover - walkable - **LG 6**

galvanised

frame profile

h = frame height
from 25 to 40 mm

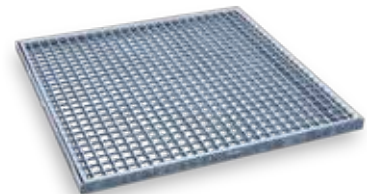
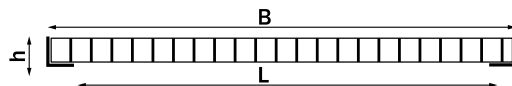

Type / Item	KRASO® Grating Cover - walkable -			
Pump sump dimension in cm	60 x 60	80 x 80	100 x 100	120 x 120
Outer frame size in mm	B	685 x 685	885 x 885	1095 x 1095
Clear frame width in mm	L	600 x 600	800 x 800	1000 x 1000
Bearing bar in mm		25/1,7	25/2	30/2
Mesh size in mm		30/30	30/30	30/30
Concentrated load approx. in kg		150	150	150
KRASO® Grating Cover - walkable -	251 €	441 €	633 €	1.041 €

Special designs available on request!



KRASO® Inspection Shaft - concrete - **LG 3**

as maintenance opening, made of waterproof concrete (C35/45) with 12 cm strong, reinforced walls in one cast, with surrounding water pressure tight, MPA-tested construction joint tape **KRASOflex®** Duo-Fix 150 „plus“, rebar connection 8/15 and crane lifting lugs for easy placement on-site, incl. 2 opposite **KRASO®** Pipe Connections DN 160 bottom edge approx. 20 cm, suitable for KG, HT and KG 2000 pipes | **DafStB waterproof concrete guideline: stress class 1 + 2**

Type / Item	80 x 80 x 70	80 x 80 x 70	80 x 80 x 70	80 x 80 x 70
Internal dimensions in cm	80 x 80	80 x 80	80 x 80	80 x 80
Internal height in cm	70	70	70	70
	without cleaning opening	with cleaning opening, fully assembled DN 160, for sewage free of faeces	with cleaning opening, fully assembled DN 160 incl. simple backwater stopper without emergency valve, for sewage free of faeces, according to DIN EN 13564 Type 0	with cleaning opening, fully assembled DN 160 incl. backwater double stopper with emergency valve, for sewage free of faeces, according to DIN 13564 Type 2
Weight approx. in t	1,1	1,1	1,1	1,1
KRASO® Inspection Shaft - concrete -	896 €	1.125 €	1.348 €	1.492 €



KRASO® Backwater Shaft Type Q - sewage - **LG 2**

for backwater protection according to DIN EN 13564 Type F3, made of plastic, with water pressure tight surrounding, thermally welded **KRASO®** 4 Seal, concrete anchors, reinforcing ribs and 2 water pressure tight pipe connections, suitable for KG, HT and KG 2000 pipes, 1 electric pressure flap (with emergency power function), 1 manual return valve, for sewage containing faeces | **DafStB waterproof concrete guideline: stress class 1 + 2**

Type / Item	600/60	800/100
Internal dimensions in cm	60 x 60	80 x 80
Internal height in cm	60	100
Pipe connection height in cm h1/h2	6/5	7/6
Backwater diameter	DN 110	DN 160
Weight approx. in kg	28	56
KRASO® Backwater Shaft Type Q - sewage -	3.451 €	4.025 €

Special sizes and designs available on request!



KRASO® Pump Sump Type Q - thermally insulated - **LG 2**

for collecting waste water, with water pressure tight surrounding, thermally welded **KRASO®** 4 Seal, concrete anchors, reinforcing ribs, 1 piece water pressure tight KG pipe connection DN 110, surrounding approx. 10 cm thick thermal insulation | **DafStB waterproof concrete guideline: stress class 1 + 2**

Type / Item	600/60	600/80	800/100	1000/100
Internal dimensions in cm	60 x 60	60 x 60	80 x 80	100 x 100
Internal height in cm	60	80	100	100
DN 110	20	20	30	30
Weight approx. in kg	49	60	113	143
KRASO® Pump Sump Type Q - thermally insulated -	Prices on request !			

Special sizes and designs available on request! Modification of pipe connection height possible!



KRASO® Special Designs made of concrete

Pumps sumps, cable ducts, lift pits

- + Made of waterproof concrete, **produced exactly according to your specifications!**
All dimensions (width, length, height, wall thickness) are variable.
- + **Installation parts** such as pipe penetrations, casings or anchor rails (for lift pits) are **installed accurately.**
- + **Weather-independent production of concrete shafts up to a total weight of 20 tons!**
- + **Saves time, working hours, money and additional drainage!**
We are happy to advise you individually!



example 100 x 100 x 80 cm
total weight: approx. 1.5 t



example 140 x 70 x 65 cm
total weight: approx. 1.0 t



example 60 x 60 x 33 cm
total weight: approx. 0.5 t



example 200 x 200 x 170 cm
total weight: approx. 18.2 t

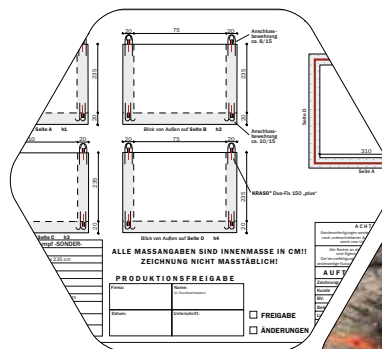

The production is carried out according to your specifications!



KRASO® Pump Sump - concrete - special

internal dimensions approx.: 310 x 75 x 235 cm, made of waterproof concrete, with 20 cm thick, reinforced wall and base plates (20 kg per cbm). Rebar connection approx. 8/15 double-row, water pressure tight surrounding, MPA-tested construction joint tape **KRASOflex® Duo-Fix 150 „plus“**, total weight: approx. 11.7 t

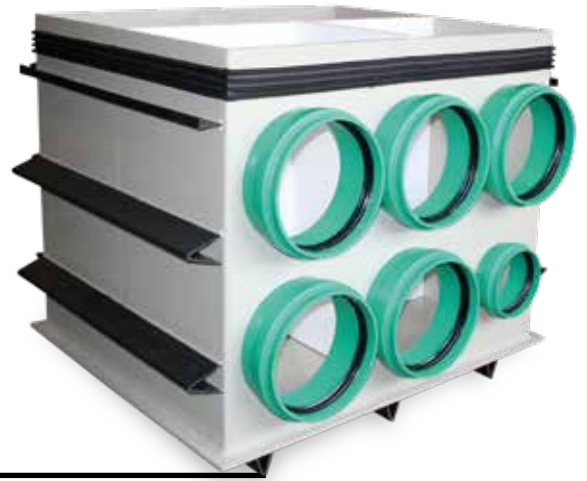

KRASO® Special Designs made of plastic Pumps sumps and cable ducts

- + Made of high-quality, impact-resistant plastic! All dimensions (width, length, height) are variable!
- + Perfect for rehabilitation projects or special designs that must be available quickly. Production within 24 hours possible!
- + Resistant against many acids and lyes!
- + We are happy to advise you individually!



example 80 x 80 x 60 cm
with flange plate for pressing on, for the sealing on an existing concrete wall, incl. EPDM supplement, drill holes Ø 12 mm to clamp and KRASO® PU 50 for adjusting unevenness of the existing wall



example 118 x 100 x 100 cm
total weight: approx. 88 kg



example 140 x 160 x 137 cm
total weight: approx. 225 kg



example 100 x 100 x 165 cm
total weight: approx. 153 kg



example 58 x 58 x 40 cm
with integrated angle frame for KRASO® Grating Cover
total weight: approx. 30 kg



example 60 x 60 x 90 cm
total weight: approx. 38 kg



example 100 x 100 x 100 cm
total weight: approx. 70 kg



example 180 x 120 x 200 cm
2 x PP pipe connection DN 500
+ 1 x PP pipe connection DN 200, with one opening of approx. 10 x 20 cm in the DN 500 pipe

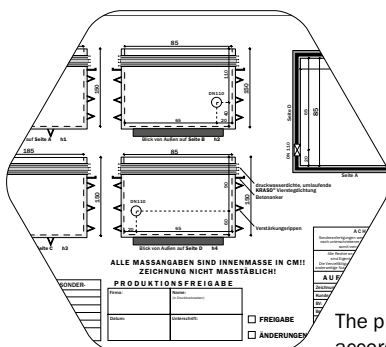

The production is carried out according to your specifications!



example 125 x 125 x 250 cm
total weight: approx. 290 kg



example 100 x 100 x 100 cm
total weight: approx. 66 kg



KRASO® Pump Sump Type Q - sewage - Low weight, high performance

- + **The high-performance solution for sewage containing faeces:** the combination of **KRASO® Pump Sump Type Q** and closed pumping system according to DIN 12050-1.
- + **Suitable for** single-family homes, basement flats, sanitation in private basements!
- + **Pumping medium:** clear water / wastewater containing solids and fibers / sewage
- + Low weight = **low transport costs and easy handling without crane on-site!**
- + **Saves time, working hours, money and additional drainage!**
We are happy to advise you individually!
- + **No higher risks** occurring by leaking concrete joints and/or pipe connections!
- + Made of high-quality, impact resistant, almost indestructible plastic.
Special dimensions are available within a few days!
- + **Double floor:** fixation of the pumping system only necessary in the upper base plate
- + **Installation and connection of the pumping system must be done by a plumbing or heating contractor**
- + Optionally available:
 - **Wedge gate valve** (on the water pressure side requested according to DIN)
 - **KRASO® Pump Sump Cover 100/100**
- + **DafStB waterproof concrete guideline: stress class 1 + 2**



wedge gate valve for
KRASO® Pump Sump Type Q - sewage -

schematic illustration

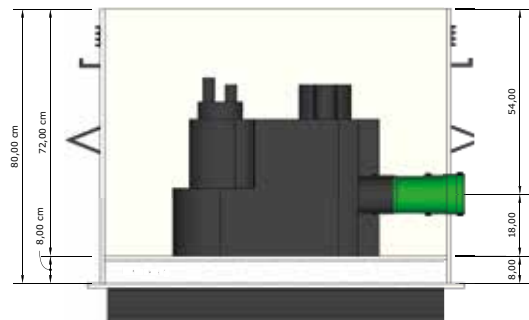

KRASO® Pump Sump Type Q - sewage - **LG 2**

for pumping out of sewage containing faeces, suitable for KG, HT and KG 2000 pipes, pumping system (excl. maintenance contract) | **DafStB waterproof concrete guideline: stress class 1 + 2**

Type / Item	KRASO® Pump Sump Type Q - sewage -
Internal dimensions in cm	100 x 100
Internal height in cm	72
DN 110 h internal (axis)	18 (modification of pipe connection height possible)
Weight approx. in kg	105
KRASO® Pump Sump Type Q - sewage -	4,310 €
Optionally available: wedge gate valve	575 €

Scope of supply: KRASO® Pump Sump Type Q - sewage -, pumping system • Optionally available: wedge gate valve

Special sizes and designs available on request! Modification of pipe connection height possible!



KRASO® Pump Sump Poly 400 - complete -
Check the installation video
(just scan the QR code!)

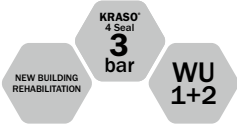

KRASO® Pump Sump Poly 400 - complete - KG 2000 Light, tight, complete

- + Light and water pressure tight complete solution for sewage free of faeces - for new buildings or rehabilitation!
- + Saves time and money: simple installation due to light weight - no additional formwork or concreting sections for several days required!
- + No higher risks occurring by leaking concrete joints and/or pipe connections!
- + DafStB waterproof concrete guideline: stress class 1 + 2



KRASO® Pump Sump Poly 400 - complete - Pump



KRASO® Pump Sump Poly 400 - complete - KG 2000 **LG 2**

for collecting and pumping out of sewage free of faeces, with shear key and pipe connection DN 110 suitable for KG, HT and KG 2000 pipes, KRASO® Poly 400 - Pump - (for sewage, excl. maintenance contract), empty pipe extension for the adjustment to subsequent floor construction | DafStB waterproof concrete guideline: stress class 1 + 2

Type / Item	KRASO® Poly 400 / 80 - complete - KG 2000	KRASO® Poly 400 / 100 - complete - KG 2000
Internal diameter in cm	37	37
Internal height in cm	80	100
Intake DN 110	h1 30	30
Empty pipe DN 110	h2 34	54
Installation weight approx. in kg	21	23
KRASO® Pump Sump Poly 400 - complete - KG 2000 - Cover: walkable	1,489 €	1,530 €
KRASO® Pump Sump Poly 400 - complete - KG 2000 - Cover: water and odour-tight	1,682 €	1,717 €

Scope of supply: 1. building shell element: KRASO® Pump Sump Poly 400 - complete - KG 2000 with protective cover, pump sump-protective cover for building shell, universal pump fastener

2. Installation set: KRASO® Poly 400 - Pump -, drain hose 1.25 m, internal diameter: 38 mm, universal hose connector 20 cm, empty pipe insert, KRASO® Sealing Insert Poly - complete -, KRASO® Poly 400 Cover - walkable -

Special sizes and designs available on request!

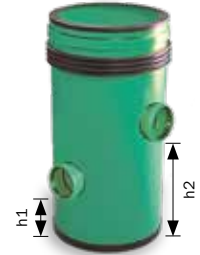
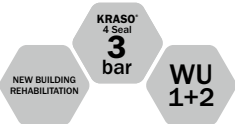

KRASO® Pump Sump Poly 400 - KG 2000 **LG 2**

for collecting waste water, with water pressure tight surrounding, thermally welded **KRASO® 4 Seal**, shear key and pipe connection DN 110, suitable for KG, HT and KG 2000 pipes | **DafStB waterproof concrete guideline: stress class 1 + 2**

Type / Item	KRASO® Poly 400 / 60 - KG 2000	KRASO® Poly 400 / 80 - KG 2000
Internal diameter in cm	37	37
Internal height in cm	60	80
DN 110	h1	20
DN 110	h2	41
Weight approx. in kg	17	21
KRASO® Pump Sump Poly 400 - KG 2000	524 €	614 €
Surcharge: per each 10 cm additional height		47 €
Surcharge: for change of the height of the connection		23 €

Special sizes and designs available on request!

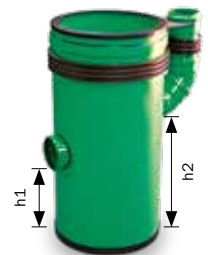

KRASO® Pump Sump Poly 400 - LR - KG 2000 **LG 2**

for collecting waste water, with water pressure tight surrounding, thermally welded **KRASO® 4 Seal**, shear key and pipe connection DN 110 suitable for KG, HT and KG 2000 pipes, water pressure tight empty pipe system with protective cover, pump sump protective cover for the shell construction phase | **DafStB waterproof concrete guideline: stress class 1 + 2**

Type / Item	KRASO® Poly 400 / 80 - LR - KG 2000	KRASO® Poly 400 / 100 - LR - KG 2000
Internal diameter in cm	37	37
Internal height in cm	80	100
Intake DN 110	h1	30
Empty pipe DN 110	h2	54
Installation weight approx. in kg	21	23
KRASO® Pump Sump Poly 400 - LR - KG 2000	841 €	866 €

Scope of supply: KRASO® Pump Sump Poly 400 - LR - KG 2000 with protective cover, pump sump protective cover for the shell construction phase

Special sizes and designs available on request!



KRASO® Pump Sump Poly 400 - NE - KG 2000 - retrofit installation **LG 2**

for retrofit installation into existing base plate with **KRASO®** Sealing Insert Type DD 500/400 (see page 13), made of high-quality, dimensionally and pressure stable solid wall material, with surrounding shear key and base for **KRASO®** Sealing Insert (not included in the scope of supply)

Type / Item	KRASO® Poly 400/60 - NE - KG 2000	KRASO® Poly 400/80 - NE - KG 2000
Internal diameter in cm	37	37
Internal height in cm	60	80
Weight approx. in kg	17	21
KRASO® Poly 400/60 - NE - KG 2000 (excl. accessories)	569 €	607 €
Surcharge: per each 10 cm additional height	47 €	
KRASO® Sealing Insert Type DD 500/400	564 €	

Special sizes and designs available on request!

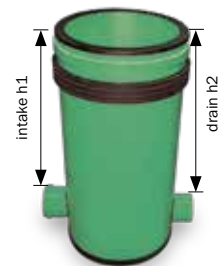
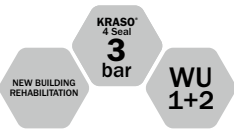

KRASO® Poly - Inspection Shaft - KG 2000 **LG 2**

for checking, maintaining and cleaning pipelines, with water pressure tight surrounding, thermally welded **KRASO®** 4 Seal and pre-installed shear key with cleaning opening, for sewage free of faeces, pipe connections DN 110/160 suitable for KG, HT and KG 2000 pipes | **DafStB waterproof concrete guideline: stress class 1 + 2**

Type / Item	KRASO® Poly - Inspection Shaft 400/80 - KG 2000	KRASO® Poly - Inspection Shaft 500/80 - KG 2000
Internal diameter in cm	37	46,9
Internal height in cm	80	80
Intake in cm	h1 76	77
Drain in cm	h2 78	78
Cleaning access pipe	DN 110	DN 160
Weight approx. in kg	18	30
KRASO® Poly - Inspection Shaft - KG 2000	702 €	1.054 €

Special sizes and designs available on request! Modification of pipe connection height possible!



after the building period:
water pressure tight closure cover with **KRASO®** Sealing Insert Type Poly 400 - Blind with lifting lugs



KRASO® Pressure Shaft 400 - KG 2000 **LG 2**

for water drainage during the building period, with water pressure tight surrounding, thermally welded **KRASO®** 4 Seal, surrounding shear key, surrounding perforated plate encasement and filter fleece, and base for **KRASO®** Sealing Insert Type Poly 400 - Blind (not included in the scope of supply) **water entry in non-installed state: with fleece 60 l/s, without fleece 90 l/s | DafStB waterproof concrete guideline: stress class 1 + 2**

Type / Item	KRASO® Pressure Shaft 400/60 - KG 2000	KRASO® Pressure Shaft 400/80 - KG 2000
Internal diameter in cm	37	37
Internal height in cm	60	80
Perforated plate encasement in cm	20	20
Weight approx. in kg	15	17
KRASO® Pressure Shaft 400 - KG 2000 (excl. accessories)	681 €	763 €
KRASO® Sealing Insert Type Poly 400 - Blind	568 €	

Special sizes and designs available on request!

KRASO® Pump Sump Poly 400 - KG 2000

Covers and accessories



height-adjustable
and rotatable
from 2 - 20 cm

Poly 400 Cover plastic - walkable -

frame and cover made of plastic,
insert frame height-adjustable
and rotatable from 2 - 20 cm,
edge length 46 cm



height-adjustable
and rotatable,
screwable
from 2 - 20 cm

Poly 400 Cover plastic - water and odour-tight - - walkable -

frame and cover made of plastic,
screwable, insert frame height-adjustable and
screwable from 2 - 20 cm, edge length 46 cm



height-adjustable
and rotatable,
screwable
from 8 - 25 cm

Poly 400 Cover plastic - fit for traffic - A15

frame and cover made of plastic,
screwable, insert frame height-adjustable and rotatable
from 8 - 25 cm,
edge length 45 cm



height-adjustable
and rotatable,
screwable
from 8 - 25 cm

Poly 400 Cover plastic - water and odour-tight - - fit for traffic - A15

frame and cover made of plastic,
insert frame height-adjustable and rotatable
from 8 - 25 cm, edge length 45 cm



height-adjustable
and rotatable
from 2 - 20 cm

Poly 400 Slot Grate Cover plastic - walkable -

frame and cover made of plastic,
drainage capacity approx. 3.9 l/sec., insert
frame height-adjustable and rotatable from 2 -
20 cm, edge length 46 cm



height-adjustable
and rotatable
from 8 - 25 cm

Poly 400 Slot Grate Cover plastic - fit for traffic - A15

frame and cover made of plastic,
drainage capacity approx. 4.1 l/sec., insert
frame height-adjustable and rotatable
from 8 - 25 cm, edge length 45 cm



height-adjustable
and rotatable
from 7 - 29 cm

Poly 400 Cover - fillable - - water and odour-tight - - fit for traffic - approx. 125 kN

edge length 53 cm, galvanised, loading after
filling with concrete C 35/45: approx. 125 kN,
height-adjustable and rotatable from 7 - 29 cm

KRASO® Pump Sump Poly 400 - Covers **LG 4**

Type / Item	
Poly 400 Cover plastic - walkable - frame and cover made of plastic, insert frame height-adjustable and rotatable from 2 - 20 cm, edge length 46 cm	195 €
Poly 400 Cover plastic - water and odour-tight - walkable - frame and cover made of plastic, screwable, insert frame height-adjustable and rotatable from 2 - 20 cm, edge length 46 cm	332 €
Poly 400 Cover plastic - fit for traffic - A15 frame and cover made of plastic, screwable, insert frame height-adjustable and rotatable from 8 - 25 cm, edge length 45 cm	340 €
Poly 400 Cover plastic - water and odour-tight - fit for traffic - A15 frame and cover made of plastic, screwable, insert frame height-adjustable and rotatable from 8 - 25 cm, edge length 45 cm	537 €
Poly 400 Slot Grate Cover plastic - walkable - frame and cover made of plastic, drainage capacity approx. 3.9 l/sec., insert frame height-adjustable and rotatable from 2 - 20 cm, edge length 46 cm	215 €
Poly 400 Slot Grate Cover plastic - fit for traffic - A15 frame and cover made of plastic, drainage capacity approx. 4.1 l/sec., insert frame height-adjustable and rotatable from 8 - 25 cm, edge length 45 cm	469 €
Poly 400 Cover - fillable - water and odour-tight - fit for traffic - approx. 125 kN edge length 53 cm, galvanised, loading after filling with concrete C 35/45: approx. 125 kN, height-adjustable and rotatable from 7 - 29 cm	518 €



additional intake for
KRASO® Pump Sump Poly 400 - KG 2000

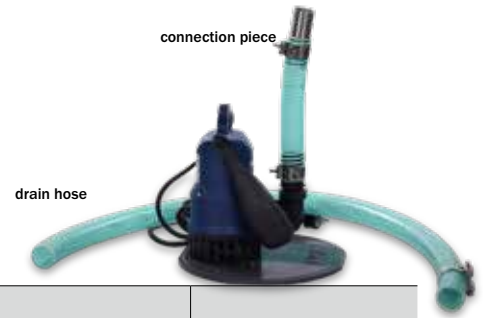

KRASO® Pump Sump Poly 400 - KG 2000 - Accessories **LG 1**

Type / Item	
Poly 400 - Pump - sludge water pump, motor, rotor shaft and screws made of non-corrosive stainless steel, suitable for permanent operation (without maintenance)	322 €
Sealing Insert Poly - complete - split version, non-corrosive stainless steel V2A, 40 mm seal, media line: 1 x 6 mm, 1 x 8 mm, 1 x 47 mm, Torque Control Nut KRASO® DKM	131 €
Connection Piece flexible, kink-resistant connection piece, 0.25 m, quick connector, stainless steel clamps	13 €
Drain Hose flexible, kink-resistant drain hose per metre, quick connector, stainless steel clamps	23 €
Protective Cover for KRASO® Pump Sump Poly 400	24 €
Additional Intake DN 110 arrangement and height according to customer's specifications	42 €
Additional Intake DN 125 arrangement and height according to customer's specifications	47 €
Additional Intake DN 160 arrangement and height according to customer's specifications	54 €



KRASO® Water Shaft **LG 1**

simple and quick "dry out" of construction-sites, with water pressure tight surrounding KRASO® 4 Seal and shear key | DafStB waterproof concrete guideline: stress class 1 + 2

Type / Item	KRASO® Water Shaft 300/30
Internal diameter in cm	30
Internal height in cm	30
Weight approx. in kg	5
KRASO® Water Shaft	132 €

Special sizes and designs available on request!

At the
construction site
even before
you!



KRASO® Logistics: simple + fast!

- + Thanks to our extensive warehousing, most orders placed before 2 pm are ready for dispatch the same day.
- + We only work with reliable and long-established logistic partners.
- + All our consignments are packed in a secure and damage-proof way and only dispatched after a detailed final inspection.
- + On request, we deliver directly to the construction-site!





KRASO®
Tenders for
your building
project!



- + Free of charge and convenient: find tenders for **KRASO® Products** quick and easily, including **product images** and **installation situations!** Also available as download for your digital tenders, allocation and billing: **Word, Excel, PDF, RTF, TXT, GAEB, Datanorm 5, ÖNORM files**
- + **KRASO® Tenders**, product lines, contact details etc. on [heinze.de](https://www.heinze.de)
KRASO® Tenders on [ausschreiben.de](https://www.ausschreiben.de)

AUSSCHREIBEN.DE



KRASO®
Product
Trainings –
how to become
an expert!

- + We offer regular training courses, where our dealers learn which product provides the right solution for particular sealing situations. At our location in Rhede/North Rhine-Westphalia, participants acquire the necessary knowledge about our products, learn about the areas of application and can discuss with our staff. Afterwards, the participants are real **KRASO® Product Experts** and can provide competent advice on sealing problems and the use of **KRASO® Products!**



KRASO®
Products – all
information
online!



- + Data sheets, test reports, tenders, product images, DWG files, installation instructions and videos can be found online for every **KRASO®** Product. Also on **KRASO.de**: current news, exhibition dates, reference objects and much more!
- + Get lots of interesting insights, practical examples and reference on our social media channels. Follow us on Facebook, Instagram and so on.

- + **KRASO® PU 50**: the high-quality, strong and permanently elastic PU sealant!
- + Recommended for all products with **KRASO® Foil Flange!** E.g. for **KRASO® Floor Penetration Type BDF with foil flange**, **KRASO® Floor Drain with foil flange**, **KRASO® Foil Clamping Flange Type FKF** (included in the delivery), **KRASO® Multi-Flange Plate Type MFP** (included in the scope of supply) etc.
- + 290 ml - cartridge for cartridge presses
- + Colour: black



KRASO®
PU 50:
strong adhesive,
permanently
elastic





KRASOflex® Construction Joint Tapes

KRASOflex® 155 (p. 135) + Duo-Fix 150 „plus“ (p. 136) + Construction Joint-Wall Element AFW 150 (p. 139) + KM-Band (p. 139) + Joint Tape A (p. 146) + Joint Tape ASI (p. 146) + Joint Tape AA (p. 147)

KRASOflex® Expansion Joint Tapes

Joint Tape AD (p. 147) + Joint Tape D (p. 147)

KRASOflex® Star Tubes

Star Tube Basis (p. 138) + Star Tube System (p. 139)

KRASOflex® Joint Plate ZVB

Joint Plate ZVB (p. 140) + Joint Plate ZVB - Desired Crack Elements (p. 141) + Formwork Elements (p. 142) + Benthonit Expansion Joint Tape (p. 143) + Expansion Rubber (p. 143)

KRASOflex® Moulded Parts

Building Expansion Joint T1 (p. 148) + Building Expansion Joint T2 (p. 148) + Construction Joint T3 (p. 149) + Wall Expansion Joint T4 (p. 149) + Building Expansion Joint T5 (p. 149) + Construction Joint T6 (p. 149)

KRASOflex® Clamp Constructions

Clamp Constructions (p. 150) + Clamp Constructions - Accessories (p. 150)

KRASOflex® Accessories

Mounting Clamp (p. 136) + Sealing Strip (p. 136)

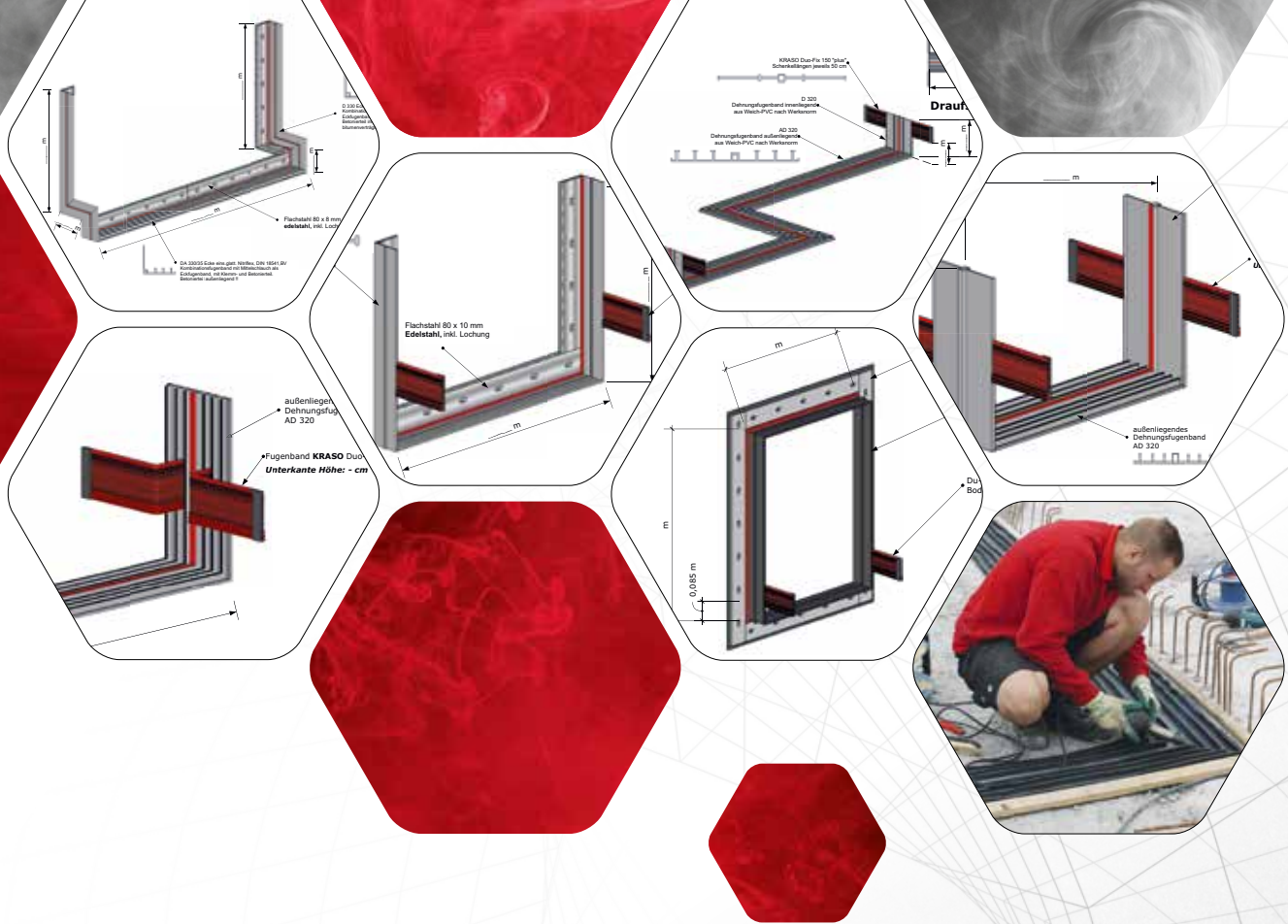

KRASO® Joint Tape Service from A to Z

Production, packaging, installation

- + **Our experience, your advantage:** we refer to your formwork and design plans for dimensions, lengths and the type of joints and develop the **appropriate solution for effective joint sealing**.
- + The production takes place under **ideal conditions** in our factory: independent of weather conditions and free of contamination. On-time delivery avoids unnecessarily long storage times on-site.
- + **Advice, measurement and installation on-site!**

„Huge construction projects require precise planning - also with regard to the various joints and the connection of existing components. With our experience and manufacturing expertise, we are at your side from the very beginning!“ Tim Weyer, Projects / Engineering

We look forward to your enquiry!

- + +49(0)28 72 - 95 35-0
- + WhatsApp +49(0)28 72 - 95 35- 888 
- + projekte@kraso.de



The joint plate made of plastic

Connections can easily be created on-site with our **KRASOflex®** Joint Connectors



The visual check helps to avoid installation errors

KRASOflex® 155 can easily be adapted and bent due to the inner core

WU
1+2

NEUBAU

KRASOflex®
Splicing Set



KRASOflex® 155

The joint plate made of plastic

- + As stable as a joint plate – flexible like a joint tape! Thanks to the inner plastic core, the **KRASOflex® 155** can easily be bent and adjusted.
- + For installation on the upper reinforcement layer – **only 3 cm of integration into the concrete required during the first concreting step. Optimal visual check due to visual control strip in different colour.**
- + Including **splicing set** for a quick and easy splicing.
- + Easy fixation due to punched eyelets.
- + **DafStB waterproof concrete guideline: stress class 1 + 2**

KRASOflex® 155 **LG 4**

Type / Item	KRASOflex® 155
Roll length / width	25 m / 150 mm
Weight per roll	approx. 20 kg
KRASOflex® 155	7.70 € per metre

Scope of supply: **KRASOflex® 155**, splicing set consisting of plastic mounting bracket, plastic adhesive, 2 joint tape clips

KRASOflex® 155 - Splicing Set **LG 4**

for **KRASOflex® 155**, for the creation of further splicing

Type / Item	KRASOflex® 155 - Joint Tape Clip Set
KRASOflex® 155 - Splicing Set	9.90 €

Scope of supply: **KRASOflex® 155 - Splicing Set** consisting of plastic mounting bracket, plastic adhesive, 2 joint tape clips



KRASOflex® Joint Tape Duo-Fix 150 „plus“
Check the installation video
(just scan the QR code!)

Stable like a joint plate – flexible like a joint tape!

KRASOflex® Mounting Clamp
for securing the impact joint!



Splicing can be created easily with **KRASOflex®** sealing strips on-site



KRASOflex® Duo-Fix 150 „plus“ can easily be adapted and bent due to the inner core

ABP

NEUBAU

**WU
1+2**

KRASOflex® Joint Tape Duo-Fix 150 „plus“ The technically high-quality construction joint tape

- + **Stable like a joint plate – flexible like a joint tape!**
KRASOflex® Duo-Fix 150 „plus“ can easily be adapted and bent due to the inner core.
- + For installation on the upper reinforcement layer – **only 3 cm of integration into the concrete required during the first concreting step.** Optimal visual control due to visual control strip in different colour.
- + Splicing can be created easily with **KRASOflex®** Sealing Strips on the construction-site.
- + Easy fixation due to punched eyelets.
- + **DafStB** waterproof concrete guideline: stress class 1 + 2

KRASOflex® Duo-Fix 150 „plus“ **LG 4**

Type / Item	KRASOflex® Duo-Fix 150 „plus“
Roll length / width	25 m / 150 mm
Weight per roll	approx. 35 kg
KRASOflex® Duo-Fix 150 „plus“	10.95 € per metre

KRASOflex® Mounting Clamps **LG 4**

for joint tapes and joint plates up to 20 cm height



Type / Item	KRASOflex® Mounting Clamp	KRASOflex® Mounting Clamp for precast walls
KRASOflex® Mounting Clamp	1.20 €	1.20 €

KRASOflex® Sealing Strips **LG 4**

for splicing, self-adhesive



Type / Item	KRASOflex® Sealing Strips
Roll (2.50 mtr.)	4.60 € per metre



THE
STAR TUBE
OF THE FUTURE

WILL ENTER

MID 2024



KRASOflex® Star Tube System
Check the installation video
(just scan the QR code!)

KRASOflex® Star Tube Basis –
slot 15 x 50 mm
next concreting step
KRASOflex® Joint Tape
ASI or on-site
joint tape / metalsheet
construction-joint

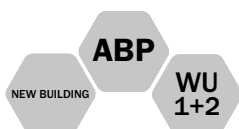
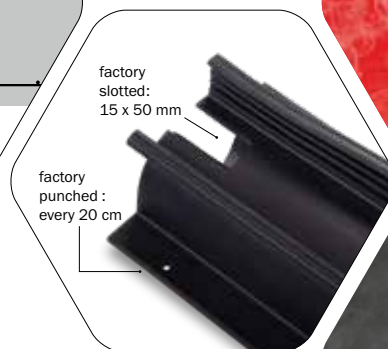
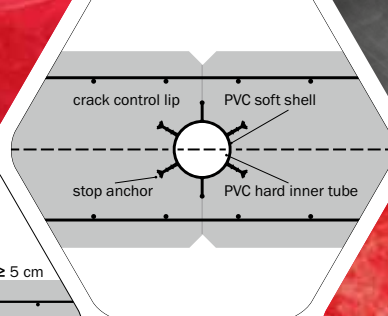
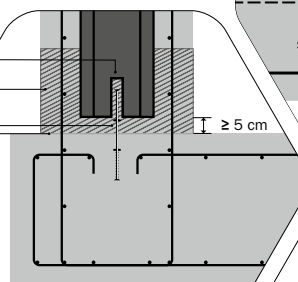

KRASOflex® Star Tube

Desired crack elements for precast and in-situ concrete walls

- + As crack inducer tubes for precast walls and in-situ concrete walls for joint or corner areas.
- + **KRASOflex® Star Tube Basis**: ready for immediate installation on joint tapes or joint plates!
- + **Factory slotted!**
- + **Factory punched every 20 cm!**
- + **KRASOflex® Star Tube System FTW 60 or OBW 88**: with two fixation sides and mounting clamps – for placement on any joint tape or joint plate!
- + **DafStB waterproof concrete guideline: stress class 1 + 2**

KRASOflex® Star Tube Basis **LG 4**

for placement on joint tape or joint plate, universally usable for joint or corner areas of wall elements | **DafStB waterproof concrete guideline: stress class 1 + 2**

Type / Item	KRASOflex® Star Tube Basis 60 • KRASOflex® Star Tube Basis 88						
Length	2.50 m	2.75 m	3.00 m	3.50 m	4.00 m	4.50 m	5.00 m
KRASOflex® Star Tube Basis 60	41,75 €	45,90 €	50,10 €	58,45 €	66,80 €	75,15 €	83,50 €
KRASOflex® Star Tube Basis 88	48,00 €	52,80 €	57,60 €	67,20 €	76,80 €	86,40 €	96,00 €

Further lengths available on request!

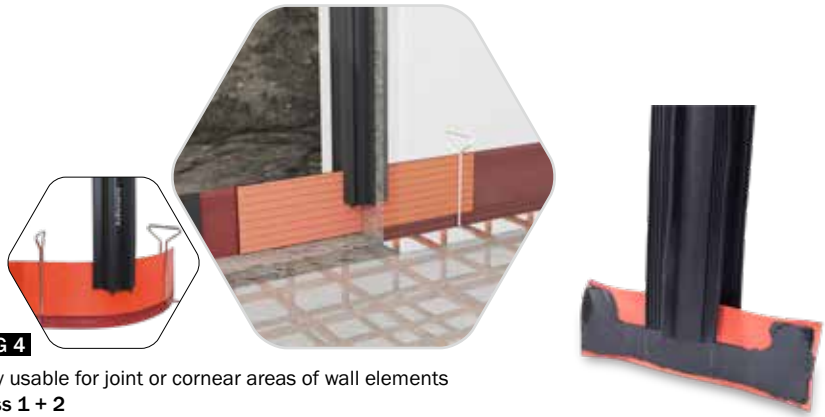
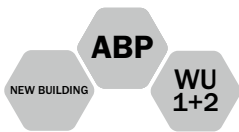

KRASOflex® Star Tube System **LG 4**

for placement on joint tape or joint plate, universally usable for joint or corner areas of wall elements
 | DafStB waterproof concrete guideline: stress class 1 + 2

Type / Item	KRASOflex® Star Tube System						
Length	2.50 m	2.75 m	3.00 m	3.50 m	4.00 m	4.50 m	5.00 m
KRASOflex® Star Tube System FTW 60 (precast walls)	86 €	92 €	95 €	107 €	120 €	135 €	146 €
KRASOflex® Star Tube System OBW 88 (in-situ walls)	108 €	116 €	121 €	135 €	148 €	164 €	179 €

Scope of supply: KRASOflex® Star Tube System incl. 50 cm fixing bracket and 2 pcs. KRASOflex® Mounting Clamps for easy fixation

Further lengths available on request!

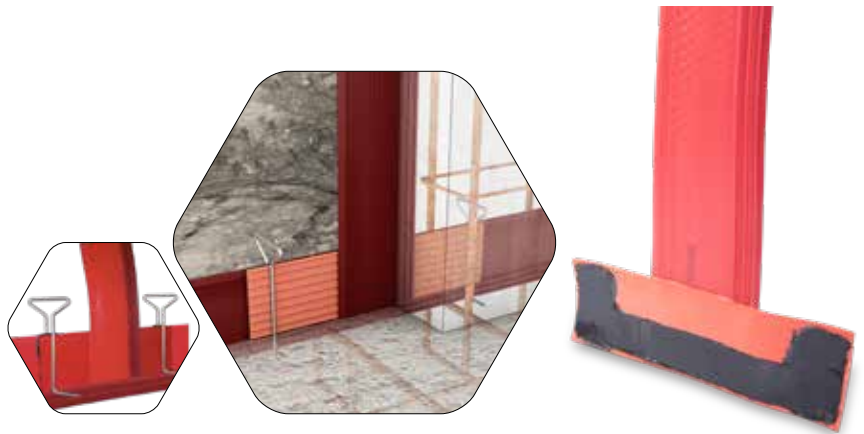
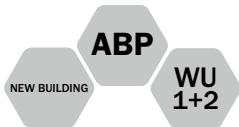

KRASOflex® AFW **LG 4**

construction joint wall element for vertical construction joints in the wall/wall joint area | DafStB waterproof concrete guideline: stress class 1 + 2

Type / Item	KRASOflex® AFW						
Length	2.50 m	2.75 m	3.00 m	3.50 m	4.00 m	4.50 m	5.00 m
KRASOflex® AFW 150	70 €	74 €	78 €	83 €	89 €	96 €	102 €
KRASOflex® AFW 155	63 €	67 €	70 €	75 €	80 €	86 €	92 €

Scope of supply: KRASOflex® AFW incl. 50 cm fixing bracket and 2 pcs. KRASOflex® Mounting Clamps for easy fixation

Further lengths available on request!

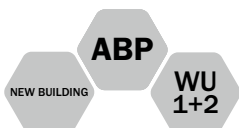

KRASOflex® KM-Band **LG 4**

internal construction joint tape – 120 or 150 mm width | DafStB waterproof concrete guideline: stress class 1 + 2

Type / Item	KRASOflex® KM-Band	
Roll length / width	25 m / 120 mm	25 m / 150 mm
Weight per roll	approx. 17 kg	approx. 21 kg
KRASOflex® KM-Band	6.30 € per metre	7.10 € per metre

KRASOflex®
Joint Plate ZVB
 - the one with mineral
 special coating

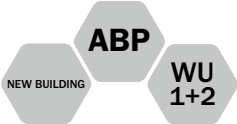

KRASOflex® Joint Plate ZVB

Cement-composite joint plate with mineral special coating

- + For the sealing of construction joints and controlled crack joints
- + Active-mineral special coating:
 active and composite sealing combined in one joint plate!
- + System solutions for in-situ concrete and precast walls
- + No sticking, no protection foil and therefore less waste on the construction-site!
- + Installation independent of weather and season!
- + DafStB waterproof concrete guideline: stress class 1 + 2



**Also
 available for
 industrial and
 agricultural
 systems!**

KRASOflex® Joint Plate ZVB **LG 4**

Type / Item	KRASOflex® Joint Plate ZVB 100	KRASOflex® Joint Plate ZVB 150
Height	100 mm	150 mm
Length	2000 mm	2000 mm
Packing Unit	100 metres / box	100 metres / box
KRASOflex® Joint Plate ZVB	7.30 € per metre	8.80 € per metre
KRASOflex® Joint Plate ZVB for industrial systems	Prices on request	Prices on request
KRASOflex® Joint Plate ZVB for agricultural systems	Prices on request	Prices on request

Scope of supply: KRASOflex® Joint Plate ZVB, fixing clips (50 pcs./box)

KRASOflex® Joint Plate ZVB - Accessories **LG 4**

Type / Item	KRASOflex® Joint Plate ZVB - Accessories			
	KRASOflex® ZVB - Fixing Clip	KRASOflex® ZVB - Mounting Clamp 150	KRASOflex® ZVB - Clamping Plate 150	KRASOflex® ZVB - Corner 150
Feature	Fixing clip for overlapping joints	Clamp for the installation on the reinforcement	Clamping plate for the connec- tion to expansion/construction joint tape	For the professional connection to precast corner elements
Packing Unit	50 Stk. / bag	25 Stk. / bag	-	-
KRASOflex® ZVB - Accessories	19 € pro bag	1.20 € per piece	29.70 € per piece	23.60 € per piece

KRASOflex® Joint Plate ZVB - Desired Crack Elements Wall Cement-composite sheet with mineral special coating

- + For the controlled production and sealing at the same time of defined desired cracks in in-situ concrete and precast walls
- + DafStB waterproof concrete guideline: stress class 1 + 2

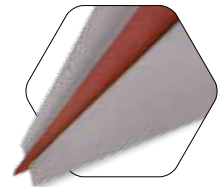

KRASOflex® Joint Plate ZVB - Desired Crack Elements OBW (in-situ concrete walls) **LG 4**

for the controlled production and sealing at the same time of defined desired cracks in in-situ concrete walls

Type / Item	KRASOflex® ZVB - desired crack joint element OBW 240/300	KRASOflex® ZVB - desired crack joint element OBW 400
Wall thickness	240 - 300 mm	up to 400 mm
Length of element	2,500 mm	2,500 mm
KRASOflex® ZVB - desired crack element OBW	42 € per metre	46.50 € per metre

Type / Item	KRASOflex® ZVB - extension element for desired crack joints OBW 240/300	KRASOflex® ZVB - extension element for desired crack joints OBW 400
Wall thickness	240 - 300 mm	up to 400 mm
Length of element	1,000 mm	1,000 mm
KRASOflex® ZVB - extension element for desired crack joints OBW	42 € per metre	46,50 € per metre

Special sizes and elements for base plates available on request!

for the professional connection of FTW corner elements see **KRASOflex® ZVB - Corner 150** (p. 140, KRASOflex® Joint Plate ZVB - accessories)

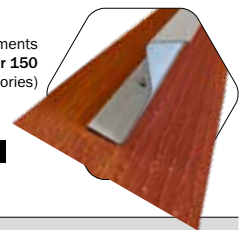

KRASOflex® Joint Plate ZVB - Desired Crack Elements FTW (precast walls) **LG 4**

for the desired production and sealing of desired cracks in precast walls

Type / Item	KRASOflex® ZVB - element for desired cracks FTW 240/250 - butt joint	KRASOflex® ZVB - element for desired cracks FTW 300 - butt joint
Wall thickness	240 - 250 mm	300 mm
Length of element	2,500 mm	2,500 mm
KRASOflex® ZVB - element for desired cracks FTW	40,50 € per metre	42 € per metre

Type / Item	KRASOflex® ZVB - extension element for desired cracks - FTW 240/250 - butt joint	KRASOflex® ZVB - extension element for desired cracks - FTW 300 butt joint
Wall thickness	240 - 250 mm	up to 300 mm
Length of element	1.000 mm	1.000 mm
KRASOflex® ZVB - extension element for desired cracks FTW - butt joint	40.50 € per metre	42 € per metre

Type / Item	KRASOflex® ZVB - element for desired cracks FTW 240/250 - corner joint	KRASOflex® ZVB - element for desired cracks FTW 300 - corner joint
Wall thickness	240 - 250 mm	300 mm
Length of element	2,500 mm	2,500 mm
KRASOflex® ZVB - element for desired cracks FTW	43.80 € per metre	45 € per metre

Type / Item	KRASOflex® ZVB - extension element for desired cracks FTW 240/250 - corner joint	KRASOflex® ZVB - extension element for desired cracks FTW 300 corner joint
Wall thickness	240 - 250 mm	up to 300 mm
Length of element	1,000 mm	1,000 mm
KRASOflex® ZVB - extension element for desired cracks FTW - butt joint	43.80 € per metre	45 € per metre

Further lengths available on request!

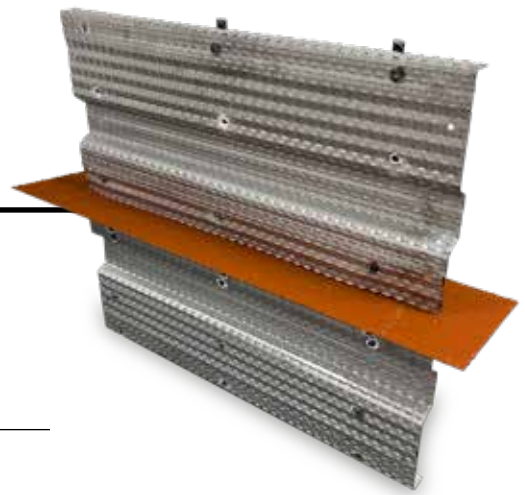

KRASOflex® Formwork Elements

Sealing and formwork in the base, wall and roof area

KRASOflex® Formwork Element ABS-R (rough) **LG 4**

Simultaneously shutter horizontal and vertical construction joints and make them watertight by installing the **KRASOflex® Joint Plate ZVB**. Joint type: rough.

Available in all standard sizes and in special designs! Prices on request!

KRASOflex® Formwork Element ABS-R-V (rough, reinforced) **LG 4**

Simultaneously shutter horizontal and vertical construction joints and make them watertight by installing the **KRASOflex® Joint Plate ZVB**. Joint type: rough, design: reinforced.

Available in all standard sizes and in special designs! Prices on request!

KRASOflex® Formwork Element ABS-V (interlocked) **LG 4**

Simultaneously shutter horizontal and vertical construction joints and make them watertight by installing the **KRASOflex® Joint Plate ZVB**. Joint type: interlocked according to EC2.

Available in all standard sizes and in special designs! Prices on request!

KRASOflex® Formwork Element ABS-V (interlocked, reinforced) **LG 4**

Simultaneously shutter horizontal and vertical construction joints and make them watertight by installing the **KRASOflex® Joint Plate ZVB**. Joint type: interlocked according to EC2, design: reinforced.

Available in all standard sizes and in special designs! Prices on request!

KRASOflex®
upstand elements
and moulds for the
formwork
on request!



KRASOflex® Bentonit Expansion Joint Tape

For the sealing of internal construction joints in in-situ concrete elements

- + Bentonit expansion joint tape for the sealing of geometrically difficult construction joints in the base area, wall and floor area
- + Strong, quick and reliable swelling reaction in contact with water. Suitable for water exchange zones!
- + Reliable sealing of joints in in-situ concrete constructions against permanent or temporary exposure by ground, slope and surface water
- + DafStB waterproof concrete guideline: stress class 1 + 2

KRASOflex® Bentonit Expansion Joint Tape **LG 4**

Type / Item	KRASOflex® Bentonit Expansion Joint Tape
Dimension	20 x 25 mm
Packing Unit	5 metres per roll / 30 metres per box
KRASOflex® Bentonit Expansion Joint Tape	11,60 € per metre

KRASOflex® Bentonit Expansion Joint Tape - Accessories **LG 4**

Type / Item	KRASOflex® Bentonit Expansion Joint Tape - Accessories	
	Mounting grid	Mounting adhesive
Length / Quantity	1 m	290 ml
KRASOflex® Bentonit Expansion Joint Tape - Accessories	2.90 €	22 €

KRASOflex® Swelling Rubber

Dimensionally stable joint sealing profile

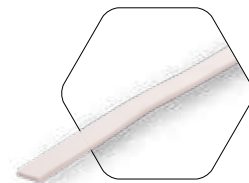

- + For joint sealing in segment construction (precast concrete elements)
- + Joint sealing profile, "dimensionally stable" swelling when in contact with water!
- + For joints in precast concrete elements for use in the construction of basements, tunnels and mine shafts!

KRASOflex® Swelling Rubber **LG 4**

Type / Item	KRASOflex® Swelling Rubber
Dimension	20 x 5 mm
Packing Unit	6 metres per roll / 72 metres per box
KRASOflex® Swelling Rubber	8.10 € per metre

KRASOflex® Mounting Adhesive **LG 4**

Type / Item	KRASOflex® Mounting Adhesive
Quantity	290 ml
KRASOflex® Mounting Adhesive	22 €



The KRASO® Economy Package - check our samples!

+ Order today:
The **KRASO® Economy Package** for the construction industry contains samples from various product categories of our numerous sealing solutions: sealing inserts, pipe penetrations, joint sealings and many more!

- + +49(0)28 72 - 95 35-0
- + WhatsApp +49(0)28 72 - 95 35-888 
- + export@kraso.de



KRASO® on the road



- + The mobile trade fair stand for your event, in-house fairs and promotion days
- + We are pleased to come to you with our **KRASO® Mobile** and to show your customers the **KRASO®** Products and sealing solutions!
- + +49(0)28 72 - 95 35-0
- + WhatsApp +49(0)28 72 - 95 35-888 
- + info@kraso.de



KRASOflex® Joint Tapes

Factory standard, DIN 18541 or DIN 18541 BV

+ Factory standard:

Joint tapes in factory standard quality are made on the basis of PCV-P (“soft PVC”).

They are perfectly suited for use in waterproof concrete structures with normal exposure.

Characterised by their excellent workability, weldability and durability, they offer a great price-performance-ratio.

+ DIN 18541:

Joint tapes of this quality level meet the requirements of the German Industry Standard for Thermoplastic joint tapes for sealing joints in concrete. Based on the material PVC-P, a special composition achieves a particular high quality in terms of elasticity, breaking extension and tensile strength. Joint tapes of this quality level are required for construction projects with very high loads.

+ DIN 18541 BV:

Joint tapes of DIN 18541 quality are also optionally available in a bitumen-compatible (BV) version.

KRASOflex®
Joint Tape A

KRASOflex®
Joint Tape AD

KRASOflex®
Joint Tape AA

KRASOflex®
Joint Tape ASI

KRASOflex®
Joint Tape D

WU
1+2

NEW BUILDING

KRASOflex® Joint Tapes

Factory standard, DIN 18541 or DIN 18541 BV

- + Internal and external construction and expansion joint tapes
- + Further joint tapes are available on request!
- + DafStB waterproof concrete guideline: stress class 1 + 2

KRASOflex® Joint Tape A **LG 4**

internal construction joint tape



Type / Item	KRASOflex® A 120	KRASOflex® A 150	KRASOflex® A 200	KRASOflex® A 240	KRASOflex® A 320
Profile width	120 mm	150 mm	200 mm	240 mm	320 mm
Roll length	25 m	25 m	25 m	25 m	25 m
KRASOflex® Joint Tape A (factory standard)	5.30 € per metre	6.40 € per metre	7.90 € per metre	9.10 € per metre	13.50 € per metre
KRASOflex® Joint Tape A (according to DIN 18541)	7.50 € per metre *	8.50 € per metre *	11.80 € per metre *	13.60 € per metre	20.40 € per metre

* according to DIN 18541, part 2

BV (bitumen-compatible) available at an additional charge!

KRASOflex® Joint Tape ASI **LG 4**

internal construction joint tape, inside stabilised (factory standard)



Type / Item	KRASOflex® ASI 120	KRASOflex® ASI 150	KRASOflex® ASI 200	KRASOflex® ASI 240	KRASOflex® ASI 320
Profile width	120 mm	150 mm	200 mm	240 mm	320 mm
Roll length	25 m	25 m	25 m	25 m	25 m
KRASOflex® Joint Tape ASI	6.30 € per metre	7.20 € per metre	8.40 € per metre	10.40 € per metre	14.90 € per metre

BV (bitumen-compatible) available at an additional charge!

KRASOflex® Joint Tape AA **LG 4**

external construction joint tape,
available in factory standard, DIN 18541 and DIN 18541 BV



Type / Item	KRASOflex® Joint Tape AA 240	KRASOflex® Joint Tape AA 320
Profile width	240 mm	320 mm
Standard anchor height	20 mm	25 mm
Roll length	25 m	25 m
KRASOflex® Joint Tape AA (factory standard)	13.60 € per metre	19.60 € per metre
KRASOflex® Joint Tape AA (35 mm anchor)	17.70 € per metre	23.90 € per metre
KRASOflex® Joint Tape AA (according to DIN 18541)	16.90 € per metre	24.50 € per metre
KRASOflex® Joint Tape AA (35 mm anchor, according to DIN 18541)	22.10 € per metre	30.30 € per metre

BV (bitumen-compatible) available at an additional charge!

KRASOflex® Joint Tape AD **LG 4**

external expansion joint tape,
available in factory standard, DIN 18541 and DIN 18541 BV

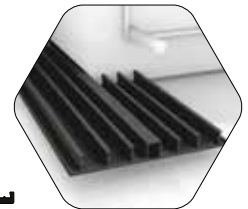

Type / Item	KRASOflex® Joint Tape AD 240	KRASOflex® Joint Tape AD 320
Profile width	240 mm	320 mm
Standard anchor height	20 mm	25 mm
Roll length	25 m	25 m
KRASOflex® Joint Tape AD (factory standard)	15.80 € per metre	20.70 € per metre
KRASOflex® Joint Tape AD (35 mm anchor)	19.60 € per metre	25 € per metre
KRASOflex® Joint Tape DA (according to DIN 18541)	19.50 € per metre	25.90 € per metre
KRASOflex® Joint Tape DA (35 mm anchor, according to DIN 18541)	24.40 € per metre	31.50 € per metre

BV (bitumen-compatible) available at an additional charge!

KRASOflex® Joint Tape D **LG 4**

internal expansion joint tape,
available in factory standard, DIN 18541 and DIN 18541 BV

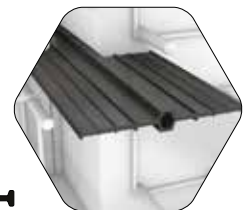

Type / Item	KRASOflex® Joint Tape D 240	KRASOflex® Joint Tape D 320
Profile width	240 mm	320 mm
Roll length	25 m	25 m
KRASOflex® Joint Tape D (factory standard)	13.40 € per metre	17.90 € per metre
KRASOflex® Joint Tape D (according to DIN 18541)	16.40 € per metre	22.30 € per metre

BV (bitumen-compatible) available at an additional charge!



NEW BUILDING
WU
1+2

KRASOflex® Joint Tapes

for building expansion joints and construction joints

+ DafStB waterproof concrete guideline: stress class 1 + 2

KRASOflex® Building Expansion Joint T1

base plate and wall separate
 corner moulding: external expansion joint tape type AD 320 (under the base plate) on external expansion joint tape type AD 320 (wall) and on **KRASOflex® Duo-Fix 150 „plus“** as connection piece for surrounding **KRASOflex® Duo-Fix 150 „plus“**, anchor lengths 50 cm each (expansion joint tapes according to factory standard, DIN 18541 and DIN 18541 BV)

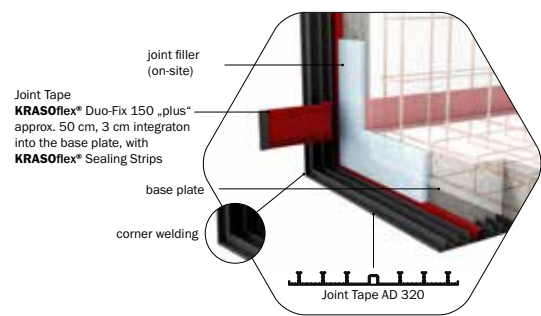

Type / Item	KRASOflex® Building Expansion Joint T1
KRASOflex® Building Expansion Joint T1	Prices on request

Scope of supply: KRASOflex® Building Expansion Joint T1 incl. 2 KRASOflex® Mounting Clamps

KRASOflex® Building Expansion Joint T2

base plate and wall separate
 corner moulding: external expansion joint tape type AD 320 (under the base plate), on internal expansion joint tape type D 320 (wall), and on **KRASOflex® Duo-Fix 150 „plus“** as connection piece, for surrounding **KRASOflex® Duo-Fix 150 „plus“**, anchor length 50 cm each (expansion joint tapes according to factory standard and DIN 18541)

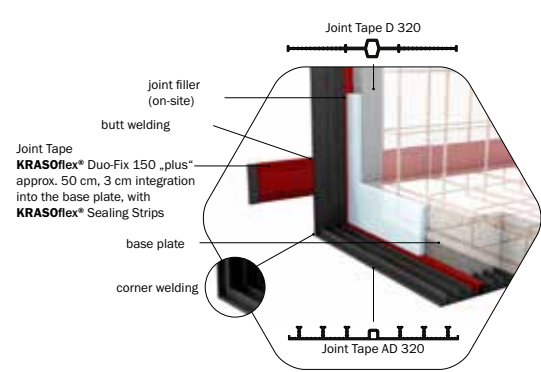

Type / Item	KRASOflex® Building Expansion Joint T2
KRASOflex® Building Expansion Joint T2	Prices on request

Scope of supply: KRASOflex® Building Expansion Joint T2 incl. 2 KRASOflex® Mounting Clamps

JOINT TAPES

KRASOflex® Construction Joint T3

base plate and wall continuous
 corner moulding: external construction joint tape type AA 320 (under the base plate)
 on external construction joint tape Type AA 320 (wall), and on **KRASOflex® Duo-Fix 150 „plus“** as connection piece for surrounding **KRASOflex® Duo-Fix 150 „plus“**, anchor length 50 cm each (construction joint tapes according to factory standard, DIN 18541 and DIN 18541 BV)

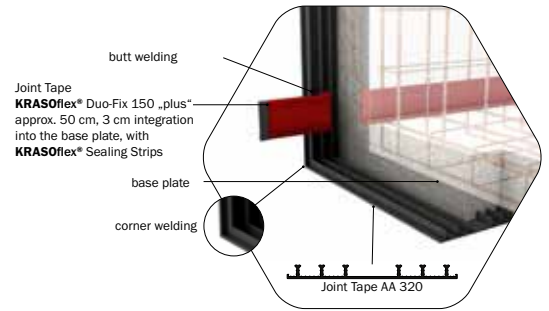

Type / Item	KRASOflex® Construction Joint T3
KRASOflex® Construction Joint T3	Prices on request

Scope of supply: KRASOflex® Construction Joint T3 incl. 2 KRASOflex® Mounting Clamps

KRASOflex® Wall Expansion Joint T4

base plate continuous and separate wall
 corner moulding: internal expansion joint tape type D 320 (wall) with anchor sections to attach the surrounding **KRASOflex® Duo-Fix 150 „plus“** (expansion joint tapes according to factory standard and DIN 18541)

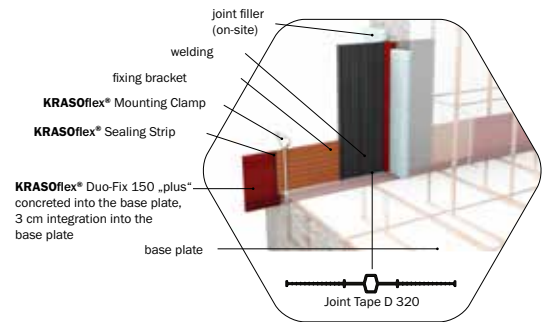

Type / Item	KRASOflex® Wall Expansion Joint T4
KRASOflex® Wall Expansion Joint T4	Prices on request

Scope of supply: KRASOflex® Wall Expansion Joint T4 incl. 2 KRASOflex® Mounting Clamps

KRASOflex® Building Expansion Joint T5

base plate and separate wall
 corner moulding: external expansion joint tape type AD 320 (under the base plate)
 on external expansion joint tape Type AD 320 Corner A (wall), and on **KRASOflex® Duo-Fix 150 „plus“** as connection piece, for surrounding **KRASOflex® Duo-Fix 150 „plus“**, anchor lengths 50 cm each (expansion joint tapes according to factory standard, DIN 18541 and DIN 18541 BV)

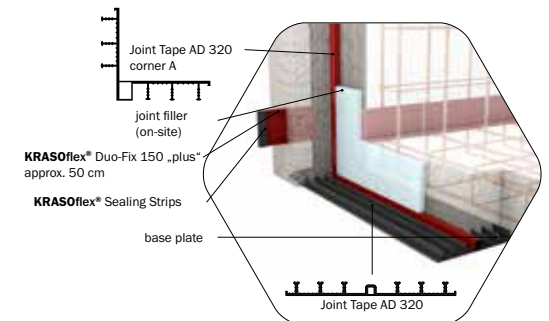

Type / Item	KRASOflex® Building Expansion Joint T5
KRASOflex® Building Expansion Joint T5	Prices on request

Scope of supply: KRASOflex® Building Expansion Joint T5 incl. 2 KRASOflex® Mounting Clamps

KRASO® Construction Joint T6

base plate continuous, joint area of triple wall (desired crack)
 corner moulding: external construction joint tape type AA 320 (under the base plate), on external construction joint tape type AA 320 (wall) and on **KRASOflex® Duo-Fix 150 „plus“** as connection piece for surrounding **KRASOflex® Duo-Fix 150 „plus“** and for adding **KRASOflex® Star Tube System FTW 60** (must be ordered separately), anchor lengths 50 cm each (construction joint tapes according to factory standard, DIN 18541 and DIN 18541 BV)

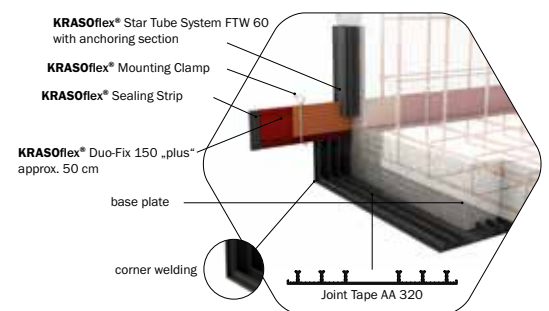

Type / Item	KRASOflex® Construction Joint T6
KRASOflex® Construction Joint T6	Prices on request

Scope of supply: KRASOflex® Construction Joint T6 incl. 2 KRASO® Mounting Clamps



KRASOflex®
Clamp Construction - external

external expansion joint tape
DA 330/35 according to DIN 18541
new element to existing element

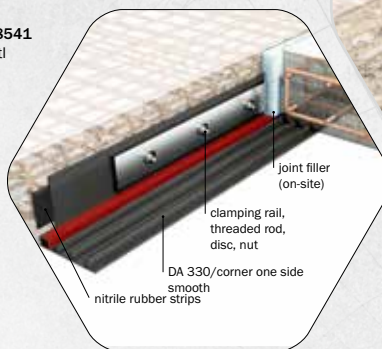

KRASOflex®
Clamp Construction - internal



KRASOflex® Clamp Constructions

For the connection of new elements to existing elements

- + Clamp Constructions in stainless steel or galvanised. Internal and external.
- + DafStB waterproof concrete guideline: stress class 1 + 2

KRASOflex® Clamp Constructions **LG 4**

Type / Item	KRASOflex® Clamp Construction			
Clamping bar flat steel (non-corrosive stainless steel V2A or galvanised, length approx. 1.20 m with slotted hole every 15 cm)	80 x 8 mm			
Nitrile rubber strips	80 x 3 mm			
Shear connector cartridges	M12			
Threaded rods (non-corrosive stainless steel V2A or galvanised)	M12 x 160 mm			
Design Joint Tape / Clamping bar flat steel	D 330 / V2A	DA 330 / V2A	D 330 / galvanised	DA 330 / galvanised
KRASOflex® Clamp Construction	195 €	198 €	165 €	168 €

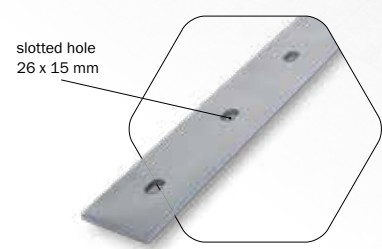

KRASOflex® Clamp Constructions - Accessories **LG 4**

Type / Item	KRASOflex® Clamp Constructions - Accessories				
	Flat steel clamp rail galvanised length approx. 1.20 m with slotted hole every 15 cm	Flat steel clamp rail V2A length approx. 1.20 m with slotted hole every 15 cm	Flat steel clamp rail V4A length approx. 1.20 m with slotted hole every 15 cm	Internal corner	External corner
	80 x 8 mm	80 x 8 mm	80 x 8 mm		
KRASOflex® Clamp Constructions - Accessories	Prices on request				
Type / Item	KRASOflex® Clamp Constructions - Accessories				
	Nitrile rubber strip	Shear connector cartridges	Threaded rods non-corrosive stainless steel V2A or galvanised	Clamp protection profile	
	80 x 3 mm	M12	M12 x 160 mm		
KRASOflex® Clamp Constructions - Accessories	Prices on request				

JOINT TAPES



Special Designs

Stainless steel

Special designs made of stainless steel (p. 152)

Plastic

Special designs made of plastic (p. 154)

Concrete

Special designs made of concrete (p. 156)



**Stainless steel –
competence and
precision**

NEW BUILDING
REHABILITATION



KRASO® Special Designs made of stainless steel

Non-corrosive stainless steel: simple and tight

- + **Sealing inserts, casings, flange plates...** We use exclusively **non-corrosive stainless steel** with the **quality seal V2A or V4A** for our special designs made of stainless steel. Solutions made of **electrogalvanised steel** are of course also possible!
- + The production takes place on e.g. **the latest laser and water-jet cutting machines!**
- + **Special designs made of stainless steel are generally ready for dispatch within 24 hours!** Direct delivery to the construction-site is possible.
- + **KRASO® Special Designs made of stainless steel are real problem solvers, particularly for rehabilitation projects!**

“Thanks to our manufacturing expertise in stainless steel, we find a suitable solution for every project - even at short notice and fully assembled by our employees.”

Jens Wenzlaff, application engineer



We look forward to your enquiry

- + +49(0)28 72 -95 35-0
- + WhatsApp +49(0)28 72 - 95 35-888 
- + projekte@kraso.de



KRASO® Special Sealing Insert Type SD30 Blind

non-corrosive stainless steel V2A / 30 mm seal, MPA-tested up to 2.5 bar
for core drilling 110 mm, **KRASO® Special Sealing Insert Type SD 30**, non-corrosive stainless steel V2A / 30 mm seal, MPA-tested up to 2.5 bar, for core drilling 110 mm, single or multiple sealing insert, media line: 1 x to 42 mm, 2 x to 39 mm, 1 x 39.3 mm, 1 x 38.6 mm, 2 x 38.5 mm, 1 x 39.2 mm, 3 x 38.2 mm, 2 x 16.0 mm, 2 x 39.8 mm, 1 x 42.0 mm, 2 x 30 mm, 1 x 39.5 mm, 1 x 38.7 mm, 1 x 38.8 mm, 1 x 38.4 mm



KRASO® Stainless Steel Flange Plate - Special

internal diameter: 250 mm, for installation of pipes or cables: 0 to 225 mm using **KRASO® Sealing Insert**, in front of a core drilling in concrete or brick walls, plate and tubular sleeve made of V4A, with EPDM flat seal and fixing material M12, protrusion length approx. 100 mm
Plate size d = approx. 450 mm,
KRASO® Type FE/DF - ID 150 with 3 expansion parts, internal diameter: 150 mm, delivery length: approx. 180 cm,
KRASO® Special Sealing Insert Type SD 60, stainless steel V4A / 60 mm seal



KRASO® Plastic Flange Plate Type KFP - Multiple split

Plate size d = approx. 1000 x 550 mm, internal diameter: 2 x 150 mm + 1 x 80 mm + 2 x 200 mm + 1 x 60 mm, external diameter media line: 0 - 110 mm, **KRASO® Special Sealing Inserts Type SD 30-T**, split, non-corrosive stainless steel V2A / 30 mm seal, MPA-tested up to 2.5 bar, for casing Type FE or core drilling 80 mm, among others for media lines: 1 x 7.5 mm + 1 x 8.5 mm + 2 x 9.5 mm + 2 x 10.5 mm + 1 x 6 mm + 1 x 14.5 mm



KRASO® Cable Penetration KDS 150 - FL/ZE/DD - Special as cable penetration 1 x 5 - against pressing water according to DIN 18533 W2-E, tubular sleeve internal diameter: 5 x 155 mm, wall thickness: 40 cm, double-sided, with fixed-loose flange and exterior protrusion flange **FDS 150**, for concreting, for installation of media pipes using **KRASO® System Sealing Insert KDS 150** (not included in the scope of supply) or for the connection of **KRASO® KDS 150 Accessories** for buildings with exterior sealing, made of non-corrosive stainless steel V2A, with water pressure tight surrounding **KRASO 2 Seal** on one side and 10 **KRASO® KDS 150 Closure Covers**



KRASO® Sealing Insert Type SD 150 - Special

for **KRASO® Casing Type FE** or core drilling-d: 800 mm, non-corrosive stainless steel V2A, 150 mm seal against pressing water, external diameter media pipes: 1 x 679 mm



KRASO® Casing Type FL/ZA - Special

internal diameter: 2 x 200 mm + 8 x 150 mm protrusion length: approx. 80 mm with special coating, for the installation of cables or pipes from 0 to 175 and 0 to 125 mm using **KRASO® Sealing Insert**, stainless steel casing V2A for dowel-fixing (bolts, nuts and washers M20) with fixed-loose flange construction for buildings with exterior sealing („black tank“) against pressing water according to DIN 18533 W2-E



KRASO® Sealing Insert Type SD 30, Blind - Special for **KRASO® Casing Type FE** or core drilling-d: 940 mm, non-corrosive stainless steel V2A, 30 mm seal, against pressing water, MPA-tested up to 2.5 bar



KRASO® Swan Neck - Special

90° angled, flat roof penetration, galvanised design, for dowel-fixing, swivelling by 360°, nominal size: 150 mm

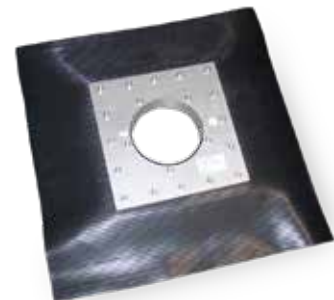

KRASO® Foil Clamping Flange Type FKF - Special

as rectangle recess, incl. **KRASO® Foil Flange**, oil- and bitumen resistant, surrounding approx. 15 cm, for the sealing of media of any kind of material, external diameter recess: 310 x 305 mm, external diameter media line: 110 mm



Plastic –
know-how and
quality!

NEW BUILDING
REHABILITATION

KRASO® Special Designs made of plastic Resistant and low weight

- + Whether drain, floor or wall penetration, pump sump or backwater shaft – **KRASO®** Special Designs made of plastic consist of **high-quality components**, for example our **solid wall, break-resistant and impact resistant KG pipes**.
- + Whether **new building or rehabilitation**: **KRASO®** Special Designs made of plastic offer a lot of advantages compared to other solutions – e.g. **low weight and an easy installation!**
- + A lot of our numerous special designs include our water pressure tight surrounding **KRASO® 4 Seal**. This is **joined monolithically (force-fit) to the solid wall pipe and thus prevents any creep or slippage by pressing water**.

*“Plastic is a very versatile material on the construction-site.
We therefore offer individual solutions for new buildings
and rehabilitation - produced and delivered at short notice.”*

Carsten Demming, application engineer

We look forward to your enquiry

- + +49(0)28 72 -95 35-0
- + WhatsApp +49(0)28 72 - 95 35-888 
- + projekte@kraso.de





KRASO® Plastic Flange Plate Type KFP multiple with foil flange - Special
for the installation of media lines using **KRASO®** Sealing Insert in front of a core drilling in concrete or masonry wall, plate made of 60 mm thick, high-strength special plastic, with EPDM flat seal, fixing and sealing material and PU 50, 1 x 250 mm, 2 x 215 mm
KRASO® Special Sealing Inserts Type SD40-T
non-corrosive stainless steel V2A / 40 mm seal
MPA-tested up to 3 bar, for KFP: 249 mm, media line: 203 mm, for KFP: 214 mm, media line: 166 mm



KRASO® Pump Sump Type Q - Special
with 15 cm surrounding fixed-flange and water pressure tight surrounding **KRASO®** 4 Seal on the fixed flange, reinforcing ribs and concrete anchors and 35 water pressure tight KG pipe connections
internal dimensions: approx. 145 x 170 x 135 cm
total weight: approx. 290 kg



KRASO® Plastic Flange Plate Type KFP 150 Multiple 2x4
8 x 160 mm with welded KG 2000 spigot for the connection of a hose connection (10 cm protrusion length)
MPA-tested up to 3 bar, plate made of 60 mm thick, high-strength special plastic, with EPDM flat seal, fixing and sealing material and PU 50,
wall opening incl. chamfer strip : 930 x 550
plate size external = approx. 1090 x 710 mm



KRASO® Pump Sump Type Q - Special
with 15 cm surrounding fixed-flange and water pressure tight surrounding **KRASO®** 4 Seal on the fixed-flange, reinforcing ribs and concrete anchors and 35 water pressure tight KG pipe connections
internal dimensions: approx. 145 x 170 x 135 cm
total weight: approx. 290 kg

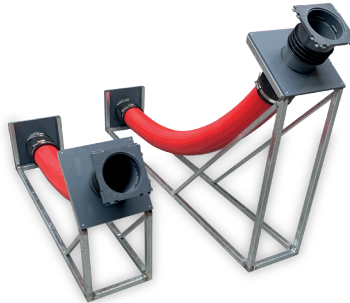

KRASO® Cable Inlet Box System KDS 150 - Special
bending radius approx. 200 cm, for the secure connection of supply lines such as e.g. water - electricity - telecommunication etc. in buildings without basement. With installation device, empty pipe insert 20 cm and water pressure tight surrounding **KRASO®** 4 Seal and 2 **KRASO®** KDS Closure Covers



KRASO® Cable Penetration KDS 150 with trowel flange as double wall penetration
1 x 8, 2 x 6, with **KRASO®** Spacer 40 mm for KDS 150 double wall penetration for the enlargement of the centre distance from 210 mm to 250 mm, roughened trowel flange, with KDS Closure Covers



KRASO® Cable Inlet Box System KDS 150 - 2x3 - Special
with water pressure tight surrounding **KRASO®** 4 Seal, suitable **KRASO®** KDS empty pipe insert 20 cm, 90° empty pipe system, installation device and 12 **KRASO®** KDS 150 Closure Covers



KRASO® Multi System Penetration Type FE 2 x 11 - Special
plate size approx. 1495 x 590 mm, incl. 22 casings ID 80, water pressure tight surrounding **KRASO®** 4 Seal on the plate and surrounding trowel flange roughened, wall thickness approx. 560 mm



**Material
concrete –
flexibility in one
piece cast!**

NEW BUILDING
REHABILITATION

KRASO® Special Designs made of concrete

Precast concrete elements save time and money

- + **Pump sumps, cable ducts, lift pits** – made of waterproof concrete, **produced exactly as per your specifications!** All dimensions (width, length, height, wall thickness) are variable.
- + **Mounting parts** like pipe penetrations, casings or anchor rails (for lift pits) are installed accurately.
- + **Weather-independent production of concrete shafts up to a total gross weight of 20 tons** - but also pump sumps and lift pits with significantly higher weights can be produced.
- + **Saves working time, money and additional drainage!** We are happy to advise you personally!

“We produce precast concrete elements exactly according to the customer’s specifications, regardless of the weather and season. This makes it much easier to plan construction projects - both in regard to deadlines and costs.”

Michael Schwarz, application engineer

We look forward to your enquiry

- + +49(0)28 72 -95 35-0
- + WhatsApp +49(0)28 72 - 95 35-888 
- + projekte@kraso.de

KRASO
EINFACH + DICHT



KRASO® Pump Sump - concrete - Special
 internal dimensions approx. 200 x 270 x 150 cm, external dimensions approx. 250 x 320 x 175 cm, 2 **KRASO®** Casings Type FE ID 200, made of waterproof concrete, with 25 cm thick, reinforced wall and base plates (20 kg per cbm), rebar connection approx. 8/15 two-rowed, surrounding water pressure tight, MPA-tested construction joint tape **KRASOflex®** Duo-Fix 150 „plus“, 4 lifting lugs Rd30, weight/piece: approx. 15.30 t, with additional reinforcement according to the indications of the structural engineer



KRASO® Cable Duct - Special
 internal dimensions approx. 140 x 140 x 110 cm, incl. angle frame installation, made of waterproof concrete, with 20 cm thick, reinforced wall and base plates (20 kg/ per cbm), without rebar connection/joint tape, 10 **KRASO®** Cable Penetrations KDS 150 on one side, according to drawing, 4 lifting lugs Rd20, weight/piece.: approx. 5 t



KRASO® Pump Sump - concrete - Special
 internal dimensions approx. 250 x 150 x 120 cm, 3 x **KRASO®** Cable Penetration KDS 150 on one side package 1 x 3, **KRASO®** Casing Type FE ID 200 on one side with welded sleeve, made of waterproof concrete, with 20 cm thick, reinforced wall and base plates (20 kg/ per cbm), rebar connection approx. 8/15 two-rowed, surrounding water pressure tight, MPA-tested construction joint tape **KRASOflex®** Duo-Fix 150 „plus“, 4 lifting lugs Rd30, weight/piece: approx. 7.8 t



KRASO® Pump Sump - concrete - Special
 internal dimensions approx. 100 x 100 x 80 cm, made of waterproof concrete, with 12 cm thick, reinforced walls in one piece cast, rebar connection approx. 8/15 two-rowed, surrounding water pressure tight, MPA-tested construction joint tape **KRASOflex®** Duo-Fix 150 „plus“, 4 lifting lugs M20, connections: 8 x DN 110, 2 x DN 250, 2 x ID/FE 200, total weight: approx. 1.5 t



KRASO® Pump Sump - concrete - Special
 internal dimensions approx. 104 x 104 x 192 cm, made of waterproof concrete, with 20 cm thick, reinforced wall and base plate (20 kg per cbm), rebar connection approx. 8/15 two-rowed, water pressure tight surrounding, MPA-tested construction joint tape **KRASOflex®** Duo-Fix 150 „plus“, incl. PE pipe DN 124 with water pressure tight surrounding **KRASO®** 4 Seal with protrusion on both sides approx. 15 cm, 4 lifting lugs Rd20, total weight: approx. 5.94 t



KRASO® Pump Sump - concrete - Special
 internal dimensions approx. 160 x 160 x 1,95 cm, 8 **KRASO®** Casings Type FE ID 200, made of waterproof concrete, with 20 cm thick, reinforced wall and base plate (20 kg per cbm). rebar connection approx. 8/15 two-rowed, surrounding water pressure tight, MPA-tested construction joint tape **KRASOflex®** Duo-Fix 150 „plus“, 4 lifting lugs Rd30, total weight: approx. 8.80 t



KRASO® Pump Sump - concrete - Special
 internal dimensions approx. 100 x 70 x 80 cm, made of waterproof concrete, with 20 cm thick, steel fibre reinforced wall and base plate (20 kg per cbm). Rebar connection approx. 8/15 two-rowed, surrounding water pressure tight, MPA-tested construction joint tape **KRASOflex®** Duo-Fix 150 „plus“, 4 lifting lugs M20, connections: 6 x DN 125, total weight: approx. 2.4 t



KRASO® Pump Sump - concrete - Special
 internal dimensions approx. 100 x 750 x 140 cm, made of waterproof concrete, with 20 cm thick, steel fibre reinforced wall and base plate (20 kg per cbm) and 1 x pipe connection DN 110, without rebar connection, without joint tape, total weight: approx. 17.5 t



KRASO® Pump Sump - concrete - Special
 internal dimensions approx. 100 x 100 x 80 cm, made of waterproof concrete, with 12 cm thick, steel fibre reinforced wall and base plate (20 kg per cbm). Connections: 2 x DN 200, 4 x DN 110, 1 x DN 110 in the bottom, total weight: approx. 1.5 t

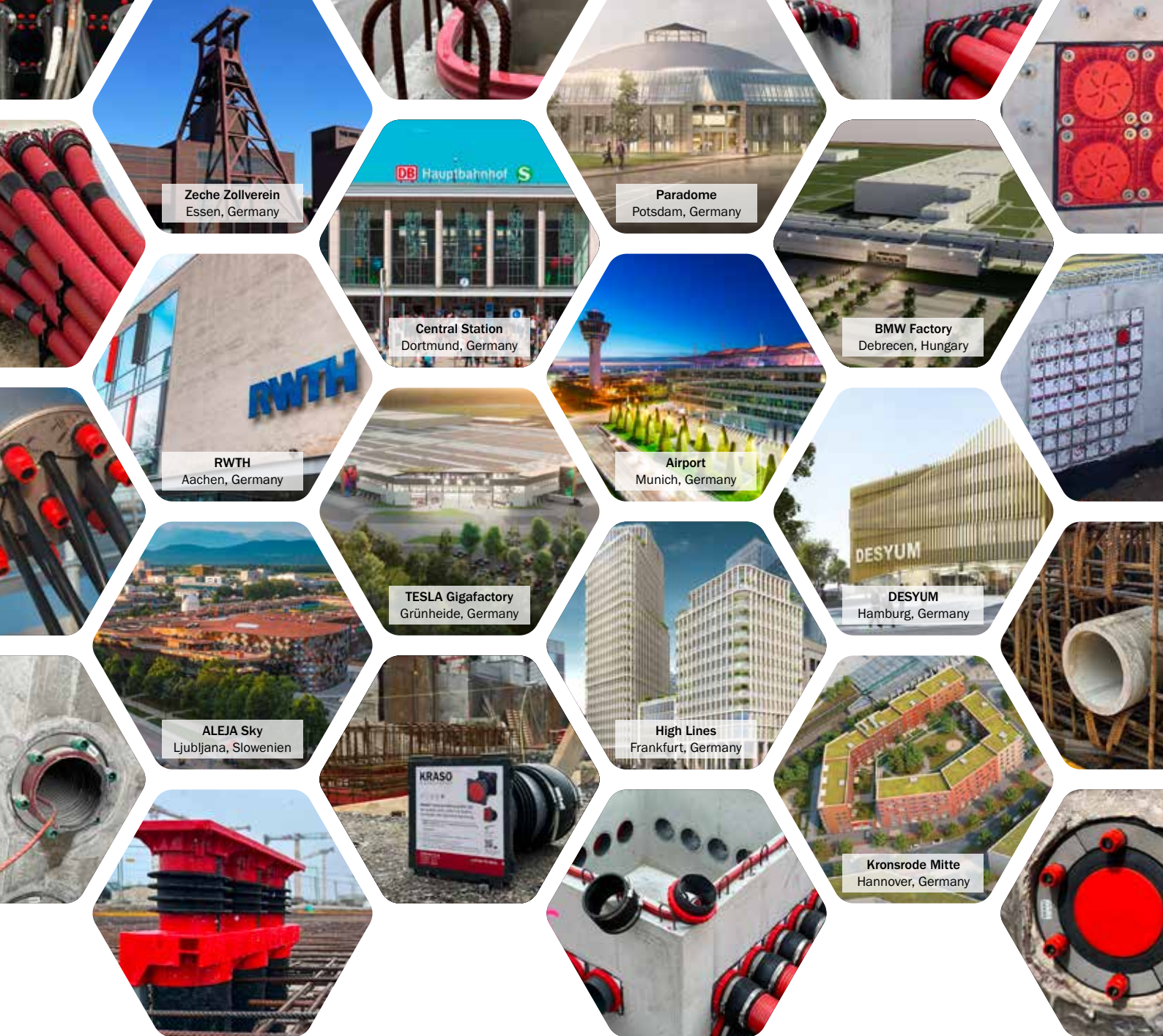

“Starting and growing a business is as much about the innovation, drive, and determination of the people behind it as the product they sell.”

Elon Musk

- + Since our foundation, our aim has always been to develop innovative solutions and continuously improve our products. With enthusiasm and a strong team, we have been pursuing this path with dedication for over 40 years - successfully!
- + As a specialist for pump sumps, joint tapes, pipe and cable penetrations, utility connection entries and outlets, sealing inserts and special designs for customised proposals, the **KRASO®** brand stands for a wide range of solutions for waterproofing buildings. From foundation to flat roof, **KRASO® Products** can be found anywhere. Tested in the laboratory, proven on the construction-site – this sets our sealing solutions apart: simple to install, tight against pressing water. Our medium-sized family-run business only has production facilities in Germany and is proud to live up to the quality recognised worldwide from products “Made in Germany”.
- + We put the emphasis on quality materials, innovative and accurate production processes, comprehensive advice - even on-site - and provide full service right up to assembly on the construction-site.



Rotation Building
Bonn, Germany

Charging park
Duisburg, Germany

Train Station
Prague, Czech Republic

Palazzo
Hertogenbosch, NL

Rotation Building
Munich, Germany



Patrick Oberkönig
Export Manager



Lamiae El Mouhdati
Int. Sales Manager MENA



Tanja Schwing
Export Manager



Philipp Münch
Sales representative
S. Germany/Switzerland



Nino Bertolini
Sales representative
Austria



Jasper Stondzik
Sales representative
The Netherlands



Michael Schwarz
Technical engineer



Carsten Demming
Technical engineer

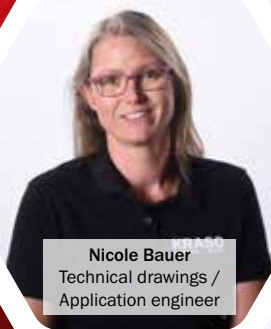

Nicole Bauer
Technical drawings /
Application engineer



Simon Böing
Technical drawings /
Order processing



Jens Wenzlaff
Technical engineer



Stefan Telaar
Technical engineer



Adrian Beckmann
Technical drawings /
Order processing

Your KRASO® contacts for daily business

Export

Patrick Oberkönig

Export

T +49(0)28 72 - 9535-388
M +49(0)17 61 - 3953 554
patrick.oberkoenig@kraso.de

Tanja Schwering

Export

T +49(0)28 72 - 9535-398
M +49(0)17 61 - 3953 546
tanja.schwering@kraso.de

International Sales

Philipp Münsch

Sales representative
South Germany, Switzerland

M +49(0)17 61 - 3953 547
philipp.muensch@kraso.de

Nino Bertolini

Sales representative
Austria

M +43(0)66 4 - 1868329
nino.bertolini@kraso.de

Jasper Stondzik

Sales representative
The Netherlands

M +49(0)17 61 - 3953 544
jasper.stondzik@kraso.de

Lamiae El Mouhdati

Int. Sales Manager
MENA

M +971(0)52- 2983293
lamiae@kraso.de

Technical engineer

Michael Schwarz

Technical engineer

T +49(0)28 72 - 9535-420
M +49(0)15 11 - 9535 105
michael.black@kraso.de

Jens Wenzlaff

Technical engineer

T +49(0)28 72 - 9535-380
M +49(0)15 11 - 9535 107
jens.wenzlaff@kraso.de

Carsten Demming

Technical engineer

T +49(0)28 72 - 9535-570
carsten.demming@kraso.de

Nicole Bauer

Technical drawings/
Application engineer

T +49(0)28 72 - 9535-180
nicole.bauer@kraso.de

Adrian Beckmann

Technical drawings/
Order processing

T +49(0)28 72 - 9535-393
adrian.beckmann@kraso.de

Simon Böing

Technical drawings/
Order processing

T +49(0)28 72 - 9535-394
simon.boeing@kraso.de

Stefan Telaar

Technical engineer

T +49(0)28 72 - 9535-620
stefan.telaar@kraso.de

Get in touch with us!

KRASO GMBH & CO. KG
Baumannweg 1 | D-46414 Rhede

Phone +49(0)28 72 - 9535-0
WhatsApp +49(0)28 72 - 9535-888 

Orders: bestellung@kraso.de
Enquiries: projekte@kraso.de
General: export@kraso.de

Our working hours:
Mon. - Thu. 7:00 am - 5:00 pm
Friday 7:00 am - 3:30 pm



TERMS AND CONDITIONS

+ Freight conditions and delivery terms as well as payment terms and discounts are subject to agreement.



... for more than 40 years +

WATER PRESSURE TIGHT INSTALLATION PARTS FOR CONCRETE ENGINEERING
SEALING SOLUTIONS FOR CABLE + PIPES



Sealing Inserts



Utility Connection -
Entries



Pump Sumps



Utility Connection -
Outlets



KRASOflex®
Joint Tapes



Cable Penetrations



Pipe Penetrations



Solutions for Fresh
Concrete Composite
Films (FBV)



Special Designs

KRASO GMBH & CO. KG
Baumannweg 1 | 46414 D-Rhede
T+49 (0) 28 72 - 95 35-0
info@kraso.de | **KRASO.de**